

IMPORTED

SOCKET SET SCREWS

..... **COMPETITIVE PRICING**

Cone Point

Flat Point

Cup Point

Oval Point

Metric (Cup Point)

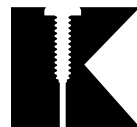

**KANEBRIDGE
CORPORATION**

**OVER
230
ITEMS**

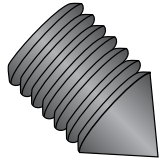

SOCKET SET SCREWS—IMPORTED
 CONE POINT / U.N.C. COARSE THREAD

Manufactured to ASME B18.3 specifications

Black Oxide

Imported

Free Mfr Certs

HARDNESS:

Rockwell C45 - 53

Coarse Thread, Class 3A / Heat Treated Alloy Steel

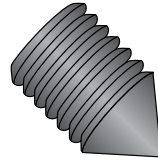
SOCKET SET SCREWS—IMPORTED
 CONE POINT / U.N.C. COARSE THREAD

Manufactured to ASME B18.3 specifications

Black Oxide

Imported

Free Mfr Certs

HARDNESS:

Rockwell C45 - 53

Coarse Thread, Class 3A / Heat Treated Alloy Steel

| Part # | Size | Ctn Qty | Standard Price/M | Special Price/M | Lbs/M |
|----------|-------------|---------|------------------|-----------------|-------|
| 0201SSNI | 2-56X1/16 | 10 | 447.70 | 407.00 | 0.05 |
| 0202SSNI | 2-56X1/8 | 10 | 278.08 | 252.80 | 0.10 |
| 0402SSNI | 4-40X1/8 | 5000 | 47.03 | 42.76 | 0.40 |
| 0403SSNI | 4-40X3/16 | 5000 | 44.88 | 40.80 | 0.50 |
| 0404SSNI | 4-40X1/4 | 5000 | 58.78 | 53.44 | 0.36 |
| 0405SSNI | 4-40X5/16 | 5000 | 64.01 | 58.19 | 0.43 |
| 0406SSNI | 4-40X3/8 | 5000 | 64.07 | 58.25 | 0.57 |
| 0408SSNI | 4-40X1/2 | 5000 | 77.13 | 70.11 | 0.80 |
| 0410SSNI | 4-40X5/8 | 5000 | 85.95 | 78.13 | 1.13 |
| 0412SSNI | 4-40X3/4 | 5000 | 95.71 | 87.01 | 1.30 |
| 0504SSNI | 5-40X1/4 | 50 | 57.60 | 52.36 | 0.70 |
| 0506SSNI | 5-40X3/8 | 10 | 203.72 | 185.20 | 1.10 |
| 0602SSNI | 6-32X1/8 | 5000 | 61.17 | 55.61 | 0.22 |
| 0603SSNI | 6-32X3/16 | 5000 | 47.41 | 43.10 | 0.60 |
| 0604SSNI | 6-32X1/4 | 5000 | 47.13 | 42.85 | 0.70 |
| 0605SSNI | 6-32X5/16 | 5000 | 54.41 | 49.47 | 1.00 |
| 0606SSNI | 6-32X3/8 | 5000 | 45.10 | 41.00 | 1.20 |
| 0608SSNI | 6-32X1/2 | 5000 | 65.04 | 59.13 | 1.60 |
| 0610SSNI | 6-32X5/8 | 5000 | 137.07 | 124.61 | 1.64 |
| 0612SSNI | 6-32X3/4 | 5000 | 165.31 | 150.28 | 1.99 |
| 0803SSNI | 8-32X3/16 | 5000 | 48.52 | 44.11 | 0.70 |
| 0804SSNI | 8-32X1/4 | 5000 | 100.86 | 91.69 | 0.90 |
| 0805SSNI | 8-32X5/16 | 5000 | 42.74 | 38.85 | 0.95 |
| 0806SSNI | 8-32X3/8 | 5000 | 44.02 | 40.02 | 1.30 |
| 0808SSNI | 8-32X1/2 | 5000 | 46.74 | 42.49 | 2.10 |
| 0810SSNI | 8-32X5/8 | 5000 | 103.72 | 94.29 | 2.50 |
| 0812SSNI | 8-32X3/4 | 5000 | 174.48 | 158.62 | 2.90 |
| 1004SSNI | 10-24X1/4 | 5000 | 41.48 | 37.71 | 1.00 |
| 1005SSNI | 10-24X5/16 | 5000 | 42.86 | 38.96 | 1.25 |
| 1006SSNI | 10-24X3/8 | 5000 | 44.18 | 40.16 | 1.80 |
| 1007SSNI | 10-24X7/16 | 5000 | 58.78 | 53.44 | 1.83 |
| 1008SSNI | 10-24X1/2 | 5000 | 44.38 | 40.35 | 2.60 |
| 1010SSNI | 10-24X5/8 | 5000 | 77.75 | 70.69 | 2.88 |
| 1012SSNI | 10-24X3/4 | 5000 | 41.48 | 37.71 | 3.63 |
| 1016SSNI | 10-24X1 | 5000 | 201.67 | 183.34 | 5.08 |
| 1404SSNI | 1/4-20X1/4 | 5000 | 43.86 | 39.88 | 1.70 |
| 1405SSNI | 1/4-20X5/16 | 5000 | 46.79 | 42.54 | 1.88 |
| 1406SSNI | 1/4-20X3/8 | 5000 | 49.46 | 44.97 | 2.30 |
| 1407SSNI | 1/4-20X7/16 | 5000 | 116.32 | 105.74 | 2.88 |
| 1408SSNI | 1/4-20X1/2 | 5000 | 55.14 | 50.13 | 3.79 |
| 1410SSNI | 1/4-20X5/8 | 5000 | 75.99 | 69.08 | 5.17 |
| 1412SSNI | 1/4-20X3/4 | 5000 | 86.27 | 78.43 | 6.50 |
| 1416SSNI | 1/4-20X1 | 5000 | 98.36 | 89.42 | 9.00 |

| Part # | Size | Ctn Qty | Standard Price/M | Special Price/M | Lbs/M |
|----------|--------------|---------|------------------|-----------------|-------|
| 3106SSNI | 5/16-18X3/8 | 50 | 76.00 | 69.09 | 3.60 |
| 3108SSNI | 5/16-18X1/2 | 50 | 72.41 | 65.83 | 5.50 |
| 3112SSNI | 5/16-18X3/4 | 25 | 117.48 | 106.80 | 10.80 |
| 3116SSNI | 5/16-18X1 | 25 | 114.52 | 104.11 | 15.00 |
| 3712SSNI | 3/8-16X3/4 | 25 | 194.21 | 176.55 | 15.00 |
| 5008SSNI | 1/2-13X1/2 | 10 | 151.50 | 137.73 | 15.00 |
| 5012SSNI | 1/2-13X3/4 | 10 | 207.56 | 188.69 | 26.00 |
| 5016SSNI | 1/2-13X1 | 10 | 265.70 | 241.54 | 37.00 |
| 5024SSNI | 1/2-13X1 1/2 | 5 | 859.60 | 781.46 | 60.00 |

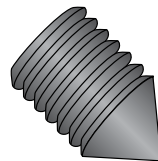
SOCKET SET SCREWS—IMPORTED
 CONE POINT / U.N.F. FINE THREAD

Manufactured to ASME B18.3 specifications

Black Oxide

Imported

Free Mfr Certs

HARDNESS:

Rockwell C45 - 53

Fine Thread, Class 3A / Heat Treated Alloy Steel

| Part # | Size | Ctn Qty | Standard Price/M | Special Price/M | Lbs/M |
|-----------|------------|---------|------------------|-----------------|-------|
| 04F02SSNI | 4-48X1/8 | 25 | 221.76 | 201.60 | 0.40 |
| 04F03SSNI | 4-48X3/16 | 25 | 256.78 | 233.44 | 0.50 |
| 1103SSNI | 10-32X3/16 | 50 | 56.91 | 51.74 | 0.90 |
| 1104SSNI | 10-32X1/4 | 5000 | 41.48 | 37.71 | 1.05 |
| 1105SSNI | 10-32X5/16 | 5000 | 52.32 | 47.56 | 1.36 |
| 1106SSNI | 10-32X3/8 | 5000 | 57.10 | 51.91 | 2.10 |
| 1107SSNI | 10-32X7/16 | 5000 | 59.87 | 54.43 | 2.07 |
| 1108SSNI | 10-32X1/2 | 5000 | 79.26 | 72.06 | 2.70 |
| 1110SSNI | 10-32X5/8 | 5000 | 79.27 | 72.06 | 3.27 |
| 1112SSNI | 10-32X3/4 | 5000 | 192.09 | 174.63 | 4.11 |
| 1116SSNI | 10-32X1 | 5000 | 209.12 | 190.11 | 5.64 |
| 1504SSNI | 1/4-28X1/4 | 50 | 49.28 | 44.80 | 3.00 |
| 1506SSNI | 1/4-28X3/8 | 50 | 49.46 | 44.96 | 3.30 |
| 1508SSNI | 1/4-28X1/2 | 25 | 93.30 | 84.82 | 5.00 |
| 1512SSNI | 1/4-28X3/4 | 10 | 154.94 | 140.85 | 7.50 |

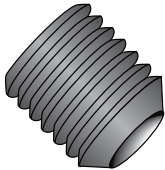

SOCKET SET SCREWS—IMPORTED
CUP POINT / U.N.R.C. COARSE THREAD

Manufactured to ASME B18.3 specifications

Black Oxide Imported Free Mfr Certs

HARDNESS:
Rockwell C45 - 53

Coarse Thread, Class 3A / Heat Treated Alloy Steel

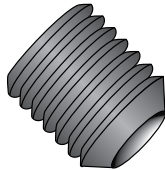

SOCKET SET SCREWS—IMPORTED
CUP POINT / U.N.R.C. COARSE THREAD

Manufactured to ASME B18.3 specifications

Black Oxide Imported Free Mfr Certs

HARDNESS:
Rockwell C45 - 53

Coarse Thread, Class 3A / Heat Treated Alloy Steel

| Part # | Size | Ctn Qty | Standard Price/M | Special Price/M | Lbs/M |
|-----------|-------------|---------|------------------|-----------------|-------|
| 0304SSCI | 3-48X1/4 | 25 | 42.59 | 38.72 | 0.29 |
| 0401SSCI | 4-40X1/16 | 10 | 193.05 | 175.50 | 0.08 |
| 0402SSCI | 4-40X1/8 | 5000 | 15.21 | 13.83 | 0.20 |
| 04033SSCI | 4-40X3/32 | 4000 | 33.83 | 30.75 | 0.13 |
| 0403SSCI | 4-40X3/16 | 5000 | 15.38 | 13.98 | 0.29 |
| 0404SSCI | 4-40X1/4 | 5000 | 15.50 | 14.09 | 0.42 |
| 0405SSCI | 4-40X5/16 | 5000 | 16.09 | 14.63 | 0.54 |
| 0406SSCI | 4-40X3/8 | 5000 | 16.55 | 15.05 | 0.63 |
| 0407SSCI | 4-40X7/16 | 5000 | 36.14 | 32.86 | 0.50 |
| 0408SSCI | 4-40X1/2 | 5000 | 19.53 | 17.75 | 0.92 |
| 0410SSCI | 4-40X5/8 | 5000 | 23.63 | 21.48 | 1.16 |
| 0412SSCI | 4-40X3/4 | 5000 | 30.29 | 27.53 | 1.42 |
| 0602SSCI | 6-32X1/8 | 5000 | 19.35 | 17.59 | 0.31 |
| 0603SSCI | 6-32X3/16 | 5000 | 13.99 | 12.72 | 0.40 |
| 0604SSCI | 6-32X1/4 | 5000 | 14.16 | 12.87 | 0.70 |
| 0605SSCI | 6-32X5/16 | 5000 | 14.73 | 13.42 | 0.81 |
| 0606SSCI | 6-32X3/8 | 5000 | 15.38 | 13.98 | 1.00 |
| 0607SSCI | 6-32X7/16 | 5000 | 16.34 | 14.85 | 1.17 |
| 0608SSCI | 6-32X1/2 | 5000 | 17.38 | 15.80 | 1.50 |
| 0610SSCI | 6-32X5/8 | 5000 | 28.59 | 25.99 | 1.75 |
| 0612SSCI | 6-32X3/4 | 5000 | 47.93 | 43.57 | 2.10 |
| 0803SSCI | 8-32X3/16 | 5000 | 13.24 | 12.03 | 0.67 |
| 0804SSCI | 8-32X1/4 | 5000 | 13.32 | 12.11 | 0.85 |
| 0805SSCI | 8-32X5/16 | 5000 | 14.36 | 13.06 | 1.10 |
| 0806SSCI | 8-32X3/8 | 5000 | 14.92 | 13.56 | 1.40 |
| 0807SSCI | 8-32X7/16 | 5000 | 16.34 | 14.85 | 1.75 |
| 0808SSCI | 8-32X1/2 | 5000 | 17.87 | 16.25 | 2.13 |
| 0810SSCI | 8-32X5/8 | 5000 | 24.94 | 22.67 | 2.58 |
| 0812SSCI | 8-32X3/4 | 5000 | 33.55 | 30.50 | 3.13 |
| 1004SSCI | 10-24X1/4 | 5000 | 12.83 | 11.66 | 1.13 |
| 1005SSCI | 10-24X5/16 | 5000 | 13.67 | 12.43 | 1.50 |
| 1006SSCI | 10-24X3/8 | 5000 | 15.32 | 13.93 | 1.75 |
| 1007SSCI | 10-24X7/16 | 5000 | 16.79 | 15.27 | 2.20 |
| 1008SSCI | 10-24X1/2 | 5000 | 17.87 | 16.25 | 2.63 |
| 1010SSCI | 10-24X5/8 | 5000 | 21.99 | 19.99 | 3.13 |
| 1012SSCI | 10-24X3/4 | 5000 | 25.48 | 23.17 | 3.92 |
| 1016SSCI | 10-24X1 | 5000 | 44.19 | 40.17 | 5.33 |
| 1404SSCI | 1/4-20X1/4 | 5000 | 15.33 | 13.94 | 1.59 |
| 1405SSCI | 1/4-20X5/16 | 5000 | 15.46 | 14.06 | 2.25 |
| 1406SSCI | 1/4-20X3/8 | 5000 | 16.81 | 15.28 | 2.93 |
| 1407SSCI | 1/4-20X7/16 | 5000 | 18.44 | 16.76 | 3.64 |
| 1408SSCI | 1/4-20X1/2 | 5000 | 19.94 | 18.13 | 4.22 |
| 1410SSCI | 1/4-20X5/8 | 5000 | 25.02 | 22.75 | 5.58 |
| 1412SSCI | 1/4-20X3/4 | 5000 | 30.20 | 27.46 | 6.94 |
| 1416SSCI | 1/4-20X1 | 5000 | 42.13 | 38.30 | 9.54 |

| Part # | Size | Ctn Qty | Standard Price/M | Special Price/M | Lbs/M |
|----------|---------------|---------|------------------|-----------------|--------|
| 1448SSCI | 1/4-20X3 | 5 | 232.17 | 211.06 | 33.00 |
| 3140SSCI | 5/16-18X2 1/2 | 5 | 298.94 | 271.76 | 29.00 |
| 5064SSCI | 1/2-13X4 | 50 | 1720.40 | 1564.00 | 169.00 |
| 8732SSCI | 7/8-9X2 | 10 | 1997.05 | 1815.50 | 229.00 |

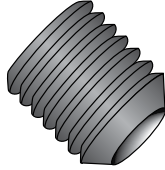

SOCKET SET SCREWS—IMPORTED
CUP POINT / U.N.F. FINE THREAD

Manufactured to ASME B18.3 specifications

Black Oxide Imported Free Mfr Certs

HARDNESS:
Rockwell C45 - 53

Fine Thread, Class 3A / Heat Treated Alloy Steel

| Part # | Size | Ctn Qty | Standard Price/M | Special Price/M | Lbs/M |
|-----------|---------------|---------|------------------|-----------------|-------|
| -001SSCI | 0-80X1/16 | 25 | 184.25 | 167.50 | 0.03 |
| -0033SSCI | 0-80X3/32 | 25 | 170.47 | 154.97 | 0.04 |
| -002SSCI | 0-80X1/8 | 25 | 177.71 | 161.55 | 0.05 |
| -003SSCI | 0-80X3/16 | 10 | 170.47 | 154.97 | 0.09 |
| -004SSCI | 0-80X1/4 | 10 | 187.79 | 170.72 | 0.13 |
| 0101SSCI | 1-72X1/16 | 25 | 179.99 | 163.63 | 0.02 |
| 01033SSCI | 1-72X3/32 | 25 | 182.96 | 166.33 | 0.04 |
| 0102SSCI | 1-72X1/8 | 10 | 169.35 | 153.95 | 0.08 |
| 0103SSCI | 1-72X3/16 | 10 | 173.40 | 157.64 | 0.13 |
| 0104SSCI | 1-72X1/4 | 10 | 178.39 | 162.17 | 0.19 |
| 1104SSCI | 10-32X1/4 | 5000 | 12.83 | 11.66 | 1.20 |
| 1105SSCI | 10-32X5/16 | 5000 | 13.67 | 12.43 | 1.51 |
| 1106SSCI | 10-32X3/8 | 5000 | 14.57 | 13.24 | 1.90 |
| 1107SSCI | 10-32X7/16 | 5000 | 17.64 | 16.04 | 2.30 |
| 1108SSCI | 10-32X1/2 | 5000 | 18.73 | 17.03 | 2.71 |
| 1109SSCI | 10-32X9/16 | 5000 | 31.67 | 28.79 | 3.17 |
| 1110SSCI | 10-32X5/8 | 5000 | 20.98 | 19.07 | 3.50 |
| 1112SSCI | 10-32X3/4 | 5000 | 25.48 | 23.17 | 4.22 |
| 1116SSCI | 10-32X1 | 5000 | 45.82 | 41.66 | 5.79 |
| 1124SSCI | 10-32X1 1/2 | 10 | 130.35 | 118.50 | 9.00 |
| 1524SSCI | 1/4-28X1 1/2 | 10 | 79.37 | 72.16 | 15.75 |
| 3220SSCI | 5/16-24X1 1/4 | 25 | 115.95 | 105.41 | 20.25 |

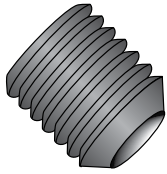
SOCKET SET SCREWS—IMPORTED
 CUP POINT / U.N.F. FINE THREAD

Manufactured to ASME B18.3 specifications

Black Oxide

Imported

Free Mfr Certs

HARDNESS:

Rockwell C45 - 53

Fine Thread, Class 3A / Heat Treated Alloy Steel

| Part # | Size | Ctn Qty | Standard Price/M | Special Price/M | Lbs/M |
|----------|---------------|---------|------------------|-----------------|--------|
| 3224SSCI | 5/16-24X1 1/2 | 25 | 261.34 | 237.58 | 23.00 |
| 3832SSCI | 3/8-24X2 | 5 | 261.34 | 237.58 | 49.60 |
| 4412SSCI | 7/16-20X3/4 | 10 | 160.33 | 145.76 | 22.00 |
| 4424SSCI | 7/16-20X1 1/2 | 5 | 462.00 | 420.00 | 47.75 |
| 4432SSCI | 7/16-20X2 | 5 | 488.87 | 444.43 | 67.00 |
| 5128SSCI | 1/2-20X1 3/4 | 5 | 519.20 | 472.00 | 75.50 |
| 5132SSCI | 1/2-20X2 | 5 | 548.45 | 498.59 | 87.00 |
| 5140SSCI | 1/2-20X2 1/2 | 5 | 810.83 | 737.12 | 111.75 |
| 6324SSCI | 5/8-18X1 1/2 | 5 | 479.42 | 435.84 | 98.50 |
| 7616SSCI | 3/4-16X1 | 5 | 405.83 | 368.94 | 85.50 |

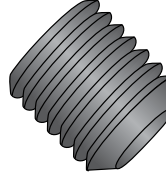
SOCKET SET SCREWS—IMPORTED
 FLAT POINT / U.N.C. COARSE THREAD

Manufactured to ASME B18.3 specifications

Black Oxide

Imported

Free Mfr Certs

HARDNESS:

Rockwell C45 - 53

Coarse Thread, Class 3A / Heat Treated Alloy Steel

| Part # | Size | Ctn Qty | Standard Price/M | Special Price/M | Lbs/M |
|----------|--------------|---------|------------------|-----------------|-------|
| 1403SSFI | 1/4-20X3/16 | 5000 | 44.33 | 40.30 | 1.30 |
| 1404SSFI | 1/4-20X1/4 | 5000 | 25.08 | 22.80 | 1.65 |
| 1406SSFI | 1/4-20X3/8 | 5000 | 28.48 | 25.89 | 3.10 |
| 1408SSFI | 1/4-20X1/2 | 5000 | 34.47 | 31.33 | 4.70 |
| 1424SSFI | 1/4-20X1 1/2 | 3000 | 145.36 | 132.15 | 15.00 |
| 1432SSFI | 1/4-20X2 | 2000 | 330.22 | 300.20 | 20.00 |
| 3104SSFI | 5/16-18X1/4 | 5000 | 36.52 | 33.20 | 2.60 |
| 3105SSFI | 5/16-18X5/16 | 50 | 35.39 | 32.17 | 4.00 |
| 3106SSFI | 5/16-18X3/8 | 50 | 34.64 | 31.49 | 5.00 |
| 3112SSFI | 5/16-18X3/4 | 4000 | 64.77 | 58.88 | 11.50 |

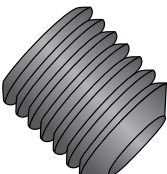
SOCKET SET SCREWS—IMPORTED
 FLAT POINT / U.N.C. COARSE THREAD

Manufactured to ASME B18.3 specifications

Black Oxide

Imported

Free Mfr Certs

HARDNESS:

Rockwell C45 - 53

Coarse Thread, Class 3A / Heat Treated Alloy Steel

| Part # | Size | Ctn Qty | Standard Price/M | Special Price/M | Lbs/M |
|----------|------------|---------|------------------|-----------------|-------|
| 0302SSFI | 3-48X1/8 | 5000 | 185.90 | 169.00 | 0.36 |
| 0403SSFI | 4-40X3/16 | 5000 | 22.31 | 20.28 | 0.50 |
| 0502SSFI | 5-40X1/8 | 5000 | 32.18 | 29.26 | 0.40 |
| 0602SSFI | 6-32X1/8 | 5000 | 23.47 | 21.34 | 0.50 |
| 0603SSFI | 6-32X3/16 | 5000 | 24.01 | 21.83 | 0.60 |
| 0604SSFI | 6-32X1/4 | 5000 | 22.21 | 20.19 | 0.64 |
| 0606SSFI | 6-32X3/8 | 5000 | 22.49 | 20.44 | 1.10 |
| 0803SSFI | 8-32X3/16 | 5000 | 23.88 | 21.71 | 0.80 |
| 0804SSFI | 8-32X1/4 | 5000 | 24.07 | 21.89 | 1.20 |
| 0806SSFI | 8-32X3/8 | 5000 | 24.45 | 22.23 | 1.46 |
| 1003SSFI | 10-24X3/16 | 5000 | 22.03 | 20.03 | 0.90 |
| 1004SSFI | 10-24X1/4 | 5000 | 21.86 | 19.87 | 1.30 |
| 1006SSFI | 10-24X3/8 | 5000 | 25.66 | 23.33 | 2.00 |

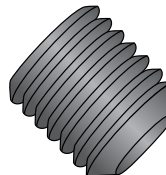
SOCKET SET SCREWS—IMPORTED
 FLAT POINT / U.N.F. FINE THREAD

Manufactured to ASME B18.3 specifications

Black Oxide

Imported

Free Mfr Certs

HARDNESS:

Rockwell C45 - 53

Fine Thread, Class 3A / Heat Treated Alloy Steel

| Part # | Size | Ctn Qty | Standard Price/M | Special Price/M | Lbs/M |
|----------|-------------|---------|------------------|-----------------|-------|
| 1102SSFI | 10-32X1/8 | 5000 | 48.44 | 44.04 | 0.52 |
| 1103SSFI | 10-32X3/16 | 5000 | 24.75 | 22.50 | 0.90 |
| 1104SSFI | 10-32X1/4 | 5000 | 23.67 | 21.52 | 1.00 |
| 1106SSFI | 10-32X3/8 | 5000 | 32.17 | 29.24 | 1.88 |
| 1108SSFI | 10-32X1/2 | 5000 | 39.07 | 35.51 | 2.68 |
| 1112SSFI | 10-32X3/4 | 5000 | 51.77 | 47.06 | 4.26 |
| 1116SSFI | 10-32X1 | 5000 | 126.45 | 114.96 | 5.80 |
| 1503SSFI | 1/4-28X3/16 | 5000 | 61.11 | 55.56 | 1.46 |
| 1504SSFI | 1/4-28X1/4 | 5000 | 25.21 | 22.92 | 2.00 |
| 1506SSFI | 1/4-28X3/8 | 50 | 32.67 | 29.70 | 3.20 |
| 1508SSFI | 1/4-28X1/2 | 25 | 49.31 | 44.83 | 4.76 |
| 1510SSFI | 1/4-28X5/8 | 5000 | 57.54 | 52.31 | 6.06 |
| 3208SSFI | 5/16-24X1/2 | 5000 | 70.68 | 64.26 | 7.26 |
| 3210SSFI | 5/16-24X5/8 | 5000 | 96.26 | 87.51 | 9.10 |
| 3212SSFI | 5/16-24X3/4 | 4000 | 115.05 | 104.59 | 11.57 |
| 3804SSFI | 3/8-24X1/4 | 5000 | 187.37 | 170.34 | 4.20 |
| 3812SSFI | 3/8-24X3/4 | 3000 | 173.99 | 158.18 | 16.57 |

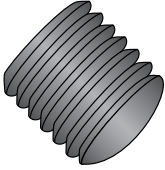

SOCKET SET SCREWS—IMPORTED
 OVAL POINT / U.N.C. COARSE THREAD

Manufactured to ASME B18.3 specifications

Black Oxide Imported Free Mfr Certs

HARDNESS:
 Rockwell C45 - 53

Coarse Thread, Class 3A / Heat Treated Alloy Steel

METRIC

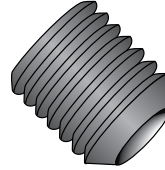

SOCKET SET SCREWS—IMPORTED
 CUP POINT / ISO METRIC THREAD

Manufactured to ISO 4029 dimensions

Black Oxide Imported Free Mfr Certs

HARDNESS:
 Rockwell C45 - 53

ISO Metric Thread / Heat Treated Alloy Steel per ASTM F912M

| Part # | Size | Ctn Qty | Standard Price/M | Special Price/M | Lbs/M |
|----------|------------|---------|------------------|-----------------|-------|
| 0402SSOI | 4-40X1/8 | 5000 | 51.77 | 47.06 | 0.40 |
| 0403SSOI | 4-40X3/16 | 5000 | 37.99 | 34.54 | 0.50 |
| 0603SSOI | 6-32X3/16 | 5000 | 35.41 | 32.19 | 0.60 |
| 0604SSOI | 6-32X1/4 | 5000 | 25.84 | 23.49 | 0.80 |
| 0804SSOI | 8-32X1/4 | 5000 | 29.42 | 26.75 | 0.90 |
| 0805SSOI | 8-32X5/16 | 5000 | 42.08 | 38.25 | 1.43 |
| 0806SSOI | 8-32X3/8 | 5000 | 40.60 | 36.91 | 2.00 |
| 1412SSOI | 1/4-20X3/4 | 25 | 71.18 | 64.71 | 6.65 |
| 1416SSOI | 1/4-20X1 | 5000 | 88.25 | 80.23 | 9.70 |
| 3712SSOI | 3/8-16X3/4 | 2000 | 126.50 | 115.00 | 15.00 |
| 3716SSOI | 3/8-16X1 | 10 | 153.85 | 139.86 | 22.00 |
| 5016SSOI | 1/2-13X1 | 1000 | 233.98 | 212.71 | 37.00 |

| Part # | Size | Ctn Qty | Standard Price/M | Special Price/M | Lbs/M |
|----------|------------|---------|------------------|-----------------|-------|
| M3003SSC | M3-0.5X3 | 100 | 16.64 | 15.13 | 1.00 |
| M3004SSC | M3-0.5X4 | 100 | 16.68 | 15.16 | 1.00 |
| M3005SSC | M3-0.5X5 | 100 | 16.72 | 15.20 | 1.00 |
| M3006SSC | M3-0.5X6 | 100 | 18.48 | 16.80 | 1.00 |
| M3008SSC | M3-0.5X8 | 100 | 16.91 | 15.37 | 1.00 |
| M3010SSC | M3-0.5X10 | 100 | 17.84 | 16.22 | 1.00 |
| M3012SSC | M3-0.5X12 | 100 | 17.96 | 16.33 | 1.00 |
| M4004SSC | M4-0.7X4 | 100 | 20.80 | 18.91 | 1.00 |
| M4005SSC | M4-0.7X5 | 100 | 20.15 | 18.32 | 1.00 |
| M4006SSC | M4-0.7X6 | 100 | 18.39 | 16.72 | 1.00 |
| M4008SSC | M4-0.7X8 | 100 | 17.98 | 16.35 | 1.00 |
| M4010SSC | M4-0.7X10 | 100 | 21.01 | 19.10 | 1.00 |
| M4012SSC | M4-0.7X12 | 100 | 22.42 | 20.38 | 2.00 |
| M4016SSC | M4-0.7X16 | 100 | 26.71 | 24.28 | 2.00 |
| M4020SSC | M4-0.7X20 | 100 | 34.12 | 31.02 | 3.00 |
| M4025SSC | M4-0.7X25 | 100 | 50.00 | 45.45 | 4.00 |
| M5005SSC | M5-0.8X5 | 100 | 18.29 | 16.63 | 1.00 |
| M5006SSC | M5-0.8X6 | 100 | 16.68 | 15.16 | 1.00 |
| M5008SSC | M5-0.8X8 | 100 | 17.07 | 15.52 | 2.00 |
| M5010SSC | M5-0.8X10 | 100 | 27.50 | 25.00 | 2.00 |
| M5012SSC | M5-0.8X12 | 100 | 20.56 | 18.69 | 3.00 |
| M5016SSC | M5-0.8X16 | 100 | 43.98 | 39.98 | 4.00 |
| M5020SSC | M5-0.8X20 | 100 | 50.29 | 45.72 | 5.00 |
| M5025SSC | M5-0.8X25 | 100 | 71.53 | 65.03 | 6.00 |
| M6006SSC | M6-1X6 | 100 | 17.95 | 16.32 | 1.00 |
| M6008SSC | M6-1X8 | 100 | 18.33 | 16.67 | 2.00 |
| M6010SSC | M6-1X10 | 100 | 21.24 | 19.31 | 3.00 |
| M6012SSC | M6-1X12 | 100 | 38.74 | 35.22 | 4.00 |
| M6016SSC | M6-1X16 | 100 | 39.56 | 35.96 | 5.00 |
| M6020SSC | M6-1X20 | 100 | 43.80 | 39.82 | 6.00 |
| M6025SSC | M6-1X25 | 100 | 56.10 | 51.00 | 10.00 |
| M6030SSC | M6-1X30 | 100 | 108.90 | 99.00 | 10.00 |
| M6040SSC | M6-1X40 | 100 | 132.00 | 120.00 | 15.00 |
| M8008SSC | M8-1.25X8 | 100 | 27.86 | 25.32 | 4.00 |
| M8010SSC | M8-1.25X10 | 100 | 36.66 | 33.33 | 5.00 |
| M8012SSC | M8-1.25X12 | 100 | 47.50 | 43.18 | 6.00 |
| M8016SSC | M8-1.25X16 | 100 | 62.19 | 56.54 | 9.00 |
| M8020SSC | M8-1.25X20 | 100 | 96.80 | 88.00 | 10.00 |
| M8025SSC | M8-1.25X25 | 100 | 97.96 | 89.05 | 15.00 |
| M8030SSC | M8-1.25X30 | 100 | 120.71 | 109.74 | 18.00 |
| M8035SSC | M8-1.25X35 | 100 | 150.48 | 136.80 | 22.00 |
| M8040SSC | M8-1.25X40 | 100 | 175.61 | 159.64 | 26.00 |
| M8045SSC | M8-1.25X45 | 100 | 196.69 | 178.81 | 28.00 |
| M8050SSC | M8-1.25X50 | 100 | 249.53 | 226.84 | 32.00 |

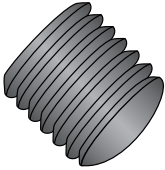

SOCKET SET SCREWS—IMPORTED
 OVAL POINT / U.N.F. FINE THREAD

Manufactured to ASME B18.3 specifications

Black Oxide Imported Free Mfr Certs

HARDNESS:
 Rockwell C45 - 53

Fine Thread, Class 3A / Heat Treated Alloy Steel

| Part # | Size | Ctn Qty | Standard Price/M | Special Price/M | Lbs/M |
|----------|------------|---------|------------------|-----------------|-------|
| 1103SSOI | 10-32X3/16 | 5000 | 34.65 | 31.50 | 1.00 |
| 1104SSOI | 10-32X1/4 | 5000 | 28.28 | 25.71 | 1.30 |
| 1105SSOI | 10-32X5/16 | 5000 | 80.30 | 73.00 | 1.40 |
| 1106SSOI | 10-32X3/8 | 5000 | 43.23 | 39.30 | 2.10 |
| 1108SSOI | 10-32X1/2 | 5000 | 52.52 | 47.75 | 2.70 |
| 1504SSOI | 1/4-28X1/4 | 5000 | 33.11 | 30.10 | 3.00 |
| 1506SSOI | 1/4-28X3/8 | 50 | 43.08 | 39.17 | 3.30 |
| 1508SSOI | 1/4-28X1/2 | 5000 | 65.82 | 59.84 | 5.00 |
| 1512SSOI | 1/4-28X3/4 | 5000 | 115.76 | 105.24 | 7.50 |
| 3810SSOI | 3/8-24X5/8 | 3000 | 319.00 | 290.00 | 12.90 |
| 3812SSOI | 3/8-24X3/4 | 3000 | 232.39 | 211.26 | 16.80 |
| 3816SSOI | 3/8-24X1 | 2000 | 452.90 | 411.73 | 23.17 |
| 5116SSOI | 1/2-20X1 | 1000 | 764.92 | 695.38 | 41.10 |

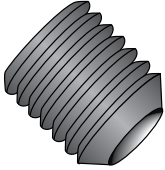

METRIC
SOCKET SET SCREWS—IMPORTED
 CUP POINT / ISO METRIC THREAD

Manufactured to ISO 4029 dimensions

Black Oxide Imported Free Mfr Certs

HARDNESS:
 Rockwell C45 - 53

ISO Metric Thread / Heat Treated Alloy Steel per ASTM F912M



METRIC
SOCKET SET SCREWS—IMPORTED
 KNURLED CUP POINT / ISO METRIC THREAD

Manufactured to ISO 4029 dimensions

Black Oxide Imported Free Mfr Certs

HARDNESS:
 Rockwell C45 - 53

ISO Metric Thread / Heat Treated Alloy Steel per ASTM F912M

| Part # | Size | Ctn Qty | Standard Price/M | Special Price/M | Lbs/M |
|------------|-------------|---------|------------------|-----------------|--------|
| M10010SSC | M10-1.5X10 | 50 | 50.65 | 46.04 | 8.00 |
| M10012SSC | M10-1.5X12 | 50 | 58.66 | 53.32 | 10.00 |
| M10016SSC | M10-1.5X16 | 50 | 163.90 | 149.00 | 11.00 |
| M10020SSC | M10-1.5X20 | 50 | 275.00 | 250.00 | 18.00 |
| M10025SSC | M10-1.5X25 | 50 | 152.01 | 138.19 | 23.00 |
| M10030SSC | M10-1.5X30 | 50 | 191.52 | 174.11 | 29.00 |
| M10035SSC | M10-1.5X35 | 50 | 222.34 | 202.12 | 34.00 |
| M10040SSC | M10-1.5X40 | 25 | 251.59 | 228.72 | 39.00 |
| M10045SSC | M10-1.5X45 | 25 | 300.55 | 273.23 | 44.00 |
| M10050SSC | M10-1.5X50 | 25 | 436.99 | 397.26 | 50.00 |
| M12012SSC | M12-1.75X12 | 25 | 124.10 | 112.82 | 13.00 |
| M12016SSC | M12-1.75X16 | 25 | 319.00 | 290.00 | 21.00 |
| M12020SSC | M12-1.75X20 | 25 | 169.01 | 153.64 | 24.00 |
| M12025SSC | M12-1.75X25 | 25 | 225.94 | 205.40 | 32.00 |
| M12030SSC | M12-1.75X30 | 25 | 256.66 | 233.32 | 42.00 |
| M12035SSC | M12-1.75X35 | 25 | 329.98 | 299.98 | 48.00 |
| M12040SSC | M12-1.75X40 | 25 | 415.44 | 377.67 | 56.00 |
| M12045SSC | M12-1.75X45 | 10 | 533.40 | 484.91 | 63.00 |
| M12050SSC | M12-1.75X50 | 10 | 490.74 | 446.12 | 67.00 |
| M16016SSC | M16-2X16 | 10 | 182.49 | 165.90 | 40.00 |
| M16020SSC | M16-2X20 | 10 | 245.73 | 223.39 | 42.00 |
| M16025SSC | M16-2X25 | 10 | 326.72 | 297.02 | 57.00 |
| M16030SSC | M16-2X30 | 10 | 649.00 | 590.00 | 71.00 |
| M16035SSC | M16-2X35 | 10 | 457.37 | 415.79 | 85.00 |
| M16050SSC | M16-2X50 | 10 | 1096.63 | 996.94 | 132.00 |
| M16060SSC | M16-2X60 | 10 | 1236.10 | 1123.72 | 156.00 |
| M20020SSC | M20-2.5X20 | 10 | 1056.42 | 960.38 | 63.00 |
| M20035SSC | M20-2.5X35 | 10 | 1500.11 | 1363.74 | 123.00 |
| M20040SSC | M20-2.5X40 | 10 | 1899.99 | 1727.26 | 147.00 |
| M20050SSCI | M20-2.5X50 | 5 | 2016.64 | 1833.31 | 190.00 |
| M20060SSC | M20-2.5X60 | 5 | 2330.59 | 2118.72 | 238.00 |

| Part # | Size | Ctn Qty | Standard Price/M | Special Price/M | Lbs/M |
|------------|-------|---------|------------------|-----------------|-------|
| M303SSCKI | M3X3 | 50 | 25.52 | 23.20 | .17 |
| M304SSCKI | M3X4 | 50 | 25.96 | 23.60 | .27 |
| M305SSCKI | M3X5 | 50 | 84.70 | 77.00 | .29 |
| M306SSCKI | M3X6 | 50 | 29.70 | 27.00 | .40 |
| M308SSCKI | M3X8 | 25 | 29.48 | 26.80 | .57 |
| M404SSCKI | M4X4 | 50 | 24.86 | 22.60 | .46 |
| M405SSCKI | M4X5 | 50 | 25.96 | 23.60 | .58 |
| M406SSCKI | M4X6 | 50 | 17.60 | 16.00 | .67 |
| M408SSCKI | M4X8 | 50 | 27.94 | 25.40 | 1.00 |
| M4010SSCKI | M4X10 | 25 | 30.14 | 27.40 | 1.29 |
| M505SSCKI | M5X5 | 50 | 27.50 | 25.00 | .82 |
| M506SSCKI | M5X6 | 50 | 32.60 | 29.64 | 1.08 |
| M508SSCKI | M5X8 | 50 | 30.36 | 27.60 | 1.59 |
| M510SSCKI | M5X10 | 50 | 32.56 | 29.60 | 1.99 |
| M606SSCKI | M6X6 | 50 | 32.56 | 29.60 | 1.50 |
| M608SSCKI | M6X8 | 50 | 34.10 | 31.00 | 2.06 |
| M6010SSCKI | M6X10 | 50 | 36.96 | 33.60 | 2.76 |
| M6012SSCKI | M6X12 | 50 | 51.06 | 46.42 | 3.50 |
| M6020SSCKI | M6X20 | 25 | 164.29 | 164.29 | 6.50 |
| M808SSCKI | M8X8 | 50 | 44.88 | 40.80 | 4.00 |
| M8010SSCKI | M8X10 | 50 | 49.21 | 44.74 | 4.63 |
| M8012SSCKI | M8X12 | 50 | 52.36 | 47.60 | 5.79 |
| M8020SSCKI | M8X20 | 10 | 84.48 | 76.80 | 11.50 |
| M8025SSCKI | M8X25 | 10 | 111.10 | 101.00 | 14.85 |
| M8030SSCKI | M8X30 | 10 | 138.91 | 126.28 | 17.93 |

Imported Socket Set Screws
Carton Quantities
Competitive Pricing
Same-Day Shipping

The **KANEBRIDGE** ADVANTAGE



Over 43,000 Items

Everything you need from one place

Kanebridge is a master distributor with over 43,000 items in inventory, including almost 10,000 stainless steel and 2,000 Military fasteners.

Same-Day Shipping / 1-Box Minimum Nobody's Faster

All orders **placed by 5pm can ship the same day** when using UPS. Emergency orders are ready within one hour. Airfreight orders placed by 7:45pm EST (4:45pm PST) can ship same day (based on stock availability in our California warehouse).

Minimum Order is 1 Box.

Fastener Specifications Guide

Your fastener questions answered!

Kanebridge's newest 6th edition of its *Fastener Specifications Guide* is available from all 3 of our branches. This hard cover reference volume is the most comprehensive & up-to-date collection of fastener specifications Kanebridge has ever compiled. The *Specification Guide* is also accessible at www.kanebridge.com.

99% Service Level

Don't wait for what you need now.

99% of the items we list are available from stock every day from one of our three warehouses located coast-to-coast: New Jersey, Illinois and California.

Drop Shipping

Use us as your extra warehouse.

Kanebridge can ship orders directly to your customer with a packing list & shipping label that identify you as the supplier. You can also use our *Custom Label* service to further simplify your supply chain.



Order By Credit Card

Instant Convenience

We accept Visa, MasterCard, Discover and American Express for new sales orders and outstanding balances.

Free Manufacturers' Certifications

Quality authenticated

Chemical & Physical certifications are available on all thru-hardened parts as well as all items made to military specifications. We keep all certifications archived and easily accessible. Call us or download the appropriate certifications directly from our website.

No Fault Return Policy

Peace of Mind

We accept returns of full cartons for any reason. There is no restock charge when items are returned within 30 days, without any alterations and accompanied by a return authorization. Parts returned after 30 days are subject to a 20% restock fee; after 90 days returns may not be accepted. Returns should be in their original boxes and must not be mingled.

Thru-hardened or military-grade fasteners will not be accepted unless returned in their original box(es).

Traceability

Pinpoint Accuracy

Lot Control is maintained on all items in our inventory.

Custom Labeling

Material Handling made easier

Streamline your receiving operations by letting Kanebridge affix custom labels to each box you order. Include all info you need: part number, description, lot number & country of origin in alphanumeric and/or bar code formats



.....

All items packed at
"Carton Quantities"

.....



T: (800) 222-9221 sales@kanebridge.com
F: (201) 337-2301 www.kanebridge.com