

BLUE DEVIL SOCKETS

- Made in America
- Packaged Quantities
- Same-Day Shipping

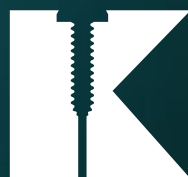

**KANEBRIDGE
CORPORATION**
New Jersey | Illinois | California

Socket Products

2017

KANEBRIDGE

Same-Day Shipping until 5 PM

- **UPS & FedEx** pick-up from each of our branches daily. For larger shipments, we can arrange for your preferred common carrier to pick-up your order--usually the same day.
- Will-Call orders can be picked up within 1 hour.

Call us: (888-222-9221)

Fax us: (201-337-2301)

Go online: www.kanebridge.com

Here to Serve You

Our Customer Service Department can be contacted 7:30 AM - 8:00 PM Eastern, Monday thru Friday. Our e-commerce site, FasNet™, is available 24/7.

Domestic Manufacture

The Blue Devil® brand is a high-quality line of **socket products, dowel pins and pipe plugs.**

All of the inch-sized Blue Devil® sockets, pins and plugs are manufactured exclusively in the United States.

All metric sizes of Blue Devil® socket head cap, button and flat head screws are made in the U.S.A. The metric Set screws come from U.S. and foreign manufacturers.

All of Kanebridge's Military-grade socket cap screws are domestically manufactured. All MS & NAS-spec parts come with full military certification at no additional charge.

Our Specialty

Over **99% of the items** we sell are available from our shelves **today!** That includes military & commercial fasteners, steel & stainless, inch-sized & metric parts. All orders placed by 5PM can ship the same day.

All of our Socket Products

This booklet lists our most current selection of socket products. This includes steel and stainless items as well as our unique selection of Alloy Steel socket cap screws with Zinc plating..

For each item, we list the size, description and Kanebridge carton quantity. That quantity is the minimum order amount for each item. There is no dollar minimum requirement to place an order with Kanebridge.

Kanebridge Socket Products

Socket Cap Screws

Socket Flat Heads

Socket Button Heads

Shoulder Screws

Socket Set Screws

Dowel Pins

Pipe Plugs

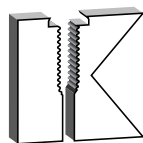

**KANEBRIDGE
CORPORATION**

New Jersey . Illinois . California

Blue Devil® Socket Products

& Dowel Pins

INCH SIZES

Socket Head Cap Screws	
<u>Alloy Steel Plain</u>	345-347
<u>Stainless Steel</u>	348
Socket Head Cap Screws, Low Head	349
Flat Head Cap Screws	349
Button Head Cap Screws	350
Socket Shoulder Screws	351
Socket Set Screws, Cup Point	352
Socket Set Screws, Oval Point	353
Socket Set Screws, Cone Point	354
Socket Set Screws, Half Dog Point	354
Socket Set Screws, Flat Point	354
Dowel Pins, Bright	355
Dowel Pins, Ebony	356
Dry Seal Socket Pipe Plug, Steel	357
Flush Seating Socket Pipe Plug, Steel	357
Dry Seal Socket Pipe Plug, <u>Brass</u>	357
Flush Seating Socket Pipe Plug, <u>Brass</u>	357

INCH SIZES (continued)

Hex Wrenches, Short Arm	357
Hex Wrenches, Long Arm	357
Hex Wrenches, Tamper Proof.....	358
Hex Wrench Sets, Short Arm	358
Hex Wrench Sets, Long Arm	358
Socket Screw Guide Slide Chart.....	358
Socket Head Cap Screws, <u>Alloy Zinc Plated</u> ..	358

METRIC SIZES

Socket Head Cap Screws, Metric	359
Flat Head Cap Screws, Metric	360
Button Head Cap Screws, Metric	361
Socket Set Screws—Cup Point, Metric	361
Hex Wrenches—Short Arm, Metric	362

Non-Blue Devil® Products

NON BLUE DEVIL® PRODUCTS

Pipe Plugs—Phillips	363
Pipe Plugs—Slotted	363

Military-Grade Domestic Sockets

MS16995 Stainless Cap Screws, Coarse.....	364
MS16996 Stainless Cap Screws, Fine	364
MS16997 Steel Cad Yellow Cap Screws.....	364
NAS1351 Stainless Cap Screws, Fine	364
NAS1351A A286 Stainless Cap Screws, Fine....	365
NAS1352 Stainless Cap Screws, Coarse	365
NAS1352A A286 Stainless Cap Screws, Coarse...	365

Alloy Steel with
Black Oxide Finish

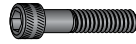

Free Manufacturer's
Certifications Available

BLUE DEVIL® BRAND SOCKET HEAD
CAP SCREWS / U.N.R.C. COARSE THREAD

All Items are Made in the U.S.A.
Manufactured to ASME B18.3 specifications
Class 3A Threads / Black Oxide Finish

Kanebridge Part #	Blue Devil® Number	Size	Ctn Qty	Wght Lbs/C
0203CSP	44000	2-56X3/16	100	0.05
0204CSP	44002	2-56X1/4	100	0.05
0206CSP	44004	2-56X3/8	100	0.07
0208CSP	44006	2-56X1/2	100	0.08
0303CSP	44008	3-48X3/16	100	0.09
0304CSP	44010	3-48X1/4	100	0.11
0306CSP	44012	3-48X3/8	100	0.12
0308CSP	44014	3-48X1/2	100	0.14
0402CSP	64100	4-40X1/8	100	0.10
0403CSP	64102	4-40X3/16	100	0.11
0404CSP	44016	4-40X1/4	100	0.13
0405CSP	64104	4-40X5/16	100	0.12
0406CSP	44018	4-40X3/8	100	0.13
0408CSP	44020	4-40X1/2	100	0.16
0410CSP	44022	4-40X5/8	100	0.18
0412CSP	44024	4-40X3/4	100	0.21
0416CSP	84024	4-40X1	100	0.31
0420CSP		4-40X1 1/4	100	0.36
0504CSP	44026	5-40X1/4	100	0.16
0506CSP	44028	5-40X3/8	100	0.20
0508CSP	44030	5-40X1/2	100	0.23
0510CSP	44032	5-40X5/8	100	0.27
0512CSP	44034	5-40X3/4	100	0.30
0602CSP	64130	6-32X1/8	100	0.17
0604CSP	44036	6-32X1/4	100	0.20
0606CSP	44038	6-32X3/8	100	0.25
0608CSP	44040	6-32X1/2	100	0.28
0610CSP	44042	6-32X5/8	100	0.32
0612CSP	44044	6-32X3/4	100	0.38
0614CSP	44046	6-32X7/8	100	0.42
0616CSP	44048	6-32X1	100	0.46
0620CSP	84050	6-32X1 1/4	100	0.59
0624CSP	84052	6-32X1 1/2	100	0.65
0632CSP		6-32X2	100	0.80
0804CSP	44050	8-32X1/4	100	0.32
0805CSP	64160	8-32X5/16	100	0.35
0806CSP	44052	8-32X3/8	100	0.37
0808CSP	44054	8-32X1/2	100	0.43
0810CSP	44056	8-32X5/8	100	0.51
0812CSP	44058	8-32X3/4	100	0.57
0814CSP	44060	8-32X7/8	100	0.63
0816CSP	44062	8-32X1	100	0.69
0820CSP	44064	8-32X1 1/4	100	0.79
0824CSP	44066	8-32X1 1/2	100	0.91
0828CSP	64170	8-32X1 3/4	100	1.15
0832CSP	64172	8-32X2	100	1.23
0840CSP		8-32X2 1/2	100	1.48
1004CSP	64180	10-24X1/4	100	0.42
1006CSP	44068	10-24X3/8	100	0.52
1008CSP	44070	10-24X1/2	100	0.64
1010CSP	44072	10-24X5/8	100	0.71
1012CSP	44074	10-24X3/4	100	0.78
1014CSP	44076	10-24X7/8	100	0.84
1016CSP	44078	10-24X1	100	0.93
1020CSP	44080	10-24X1 1/4	100	1.12
1024CSP	44082	10-24X1 1/2	100	1.26
1028CSP	44084	10-24X1 3/4	100	1.50
1032CSP	44086	10-24X2	100	1.69
1036CSP	84088	10-24X2 1/4	100	1.90
1040CSP	84090	10-24X2 1/2	100	2.14
1044CSP	64190	10-24X2 3/4	100	2.40
1048CSP	64192	10-24X3	100	2.50

More sizes on next column

Alloy Steel with
Black Oxide Finish



Free Manufacturer's
Certifications Available

BLUE DEVIL® BRAND SOCKET HEAD
CAP SCREWS / U.N.R.C. COARSE THREAD

All Items are Made in the U.S.A.
Manufactured to ASME B18.3 specifications
Class 3A Threads / Black Oxide Finish

Kanebridge Part #	Blue Devil® Number	Size	Ctn Qty	Wght Lbs/C
1404CSP	64200	1/4-20X1/4	100	0.90
1406CSP	44088	1/4-20X3/8	100	1.03
1408CSP	44090	1/4-20X1/2	100	1.14
1409CSP	64206	1/4-20X9/16	100	1.15
1410CSP	44092	1/4-20X5/8	100	1.32
1412CSP	44094	1/4-20X3/4	100	1.38
1414CSP	44096	1/4-20X7/8	100	1.52
1416CSP	44098	1/4-20X1	100	1.69
1420CSP	44100	1/4-20X1 1/4	100	2.00
1424CSP	44102	1/4-20X1 1/2	100	2.42
1428CSP	44104	1/4-20X1 3/4	100	2.56
1432CSP	44106	1/4-20X2	100	2.96
1436CSP	44108	1/4-20X2 1/4	100	3.26
1440CSP	44110	1/4-20X2 1/2	100	3.70
1444CSP	44112	1/4-20X2 3/4	100	3.96
1448CSP	44113	1/4-20X3	100	4.44
1452CSP	64230	1/4-20X3 1/4	100	4.62
1456CSP	44114	1/4-20X3 1/2	100	5.15
1464CSP	84144	1/4-20X4	100	5.58
1480CSP	64250	1/4-20X5	10	7.03
1496CSP		1/4-20X6	10	8.42
3106CSP	44116	5/16-18X3/8	100	1.76
3108CSP	44118	5/16-18X1/2	100	1.98
3110CSP	44120	5/16-18X5/8	100	2.18
3112CSP	44122	5/16-18X3/4	100	2.37
3114CSP	44124	5/16-18X7/8	100	2.60
3116CSP	44126	5/16-18X1	100	2.90
3120CSP	44128	5/16-18X1 1/4	100	3.28
3124CSP	44130	5/16-18X1 1/2	100	3.67
3128CSP	44132	5/16-18X1 3/4	100	4.36
3132CSP	44134	5/16-18X2	100	4.83
3136CSP	44136	5/16-18X2 1/4	100	5.50
3140CSP	44138	5/16-18X2 1/2	100	5.94
3144CSP	44140	5/16-18X2 3/4	100	6.63
3148CSP	44142	5/16-18X3	100	6.94
3152CSP	44144	5/16-18X3 1/4	50	7.66
3156CSP	44146	5/16-18X3 1/2	50	8.00
3160CSP	64266	5/16-18X3 3/4	50	8.22
3164CSP	84170	5/16-18X4	50	9.04
3180CSP	64270	5/16-18X5	50	10.57
3708CSP	44148	3/8-16X1/2	100	3.15
3710CSP	44150	3/8-16X5/8	100	3.42
3712CSP	44152	3/8-16X3/4	100	3.80
3714CSP	44154	3/8-16X7/8	100	4.09
3716CSP	44156	3/8-16X1	100	4.30
3718CSP	64280	3/8-16X1 1/8	100	4.80
3720CSP	44158	3/8-16X1 1/4	100	5.14
3724CSP	44160	3/8-16X1 1/2	100	5.68
3728CSP	44162	3/8-16X1 3/4	100	6.50
3732CSP	44164	3/8-16X2	100	7.09
3736CSP	44166	3/8-16X2 1/4	100	8.05
3740CSP	44168	3/8-16X2 1/2	50	8.88
3744CSP	44170	3/8-16X2 3/4	50	9.80
3748CSP	44172	3/8-16X3	50	10.30
3752CSP	44174	3/8-16X3 1/4	50	11.20
3756CSP	44176	3/8-16X3 1/2	50	11.82
3764CSP	44178	3/8-16X4	50	13.46
3772CSP	44180	3/8-16X4 1/2	50	15.02
3780CSP	44182	3/8-16X5	50	16.44
3788CSP		3/8-16X5 1/2	50	17.54
3796CSP	84202	3/8-16X6	50	19.65
4308CSP	44184	7/16-14X1/2	100	4.63
4310CSP	44186	7/16-14X5/8	100	5.15
4312CSP	44188	7/16-14X3/4	100	5.61
4314CSP	44190	7/16-14X7/8	100	6.00

More sizes on page 346

Alloy Steel with
Black Oxide Finish



Free Manufacturer's
Certifications Available

Alloy Steel with
Black Oxide Finish



Free Manufacturer's
Certifications Available

**BLUE DEVIL® BRAND SOCKET HEAD
CAP SCREWS / U.N.R.C. COARSE THREAD**

All Items are Made in the U.S.A.
Manufactured to ASME B18.3 specifications
Class 3A Threads / Black Oxide Finish

Kanebridge Part #	Blue Devil® Number	Size	Ctn Qty	Wght Lbs/C
4316CSP	44192	7/16-14X1	100	6.40
4320CSP	44194	7/16-14X1 1/4	100	7.26
4324CSP	44196	7/16-14X1 1/2	100	8.07
4328CSP	44198	7/16-14X1 3/4	50	9.26
4332CSP	44200	7/16-14X2	50	10.44
4336CSP	44202	7/16-14X2 1/4	50	11.28
4340CSP	44204	7/16-14X2 1/2	50	12.10
4344CSP	44206	7/16-14X2 3/4	50	13.36
4348CSP	44208	7/16-14X3	50	14.54
4352CSP	44210	7/16-14X3 1/4	50	15.36
4356CSP	44212	7/16-14X3 1/2	50	17.00
4364CSP	44214	7/16-14X4	50	18.58
4372CSP		7/16-14X4 1/2	25	20.26
5008CSP	44216	1/2-13X1 1/2	100	7.10
5010CSP	44218	1/2-13X5/8	100	7.70
5012CSP	44220	1/2-13X3/4	100	8.29
5014CSP	44222	1/2-13X7/8	100	8.86
5016CSP	44224	1/2-13X1	100	9.26
5020CSP	44226	1/2-13X1 1/4	100	10.37
5024CSP	44228	1/2-13X1 1/2	100	11.52
5028CSP	44230	1/2-13X1 3/4	50	12.76
5032CSP	44232	1/2-13X2	50	13.92
5036CSP	44234	1/2-13X2 1/4	50	15.46
5040CSP	44236	1/2-13X2 1/2	50	16.52
5044CSP	44238	1/2-13X2 3/4	50	17.80
5048CSP	44240	1/2-13X3	50	19.74
5052CSP	44242	1/2-13X3 1/4	50	20.78
5056CSP	44244	1/2-13X3 1/2	50	21.88
5060CSP	64320	1/2-13X3 3/4	50	24.60
5064CSP	44246	1/2-13X4	50	24.80
5068CSP	64330	1/2-13X4 1/4	50	26.60
5072CSP	44248	1/2-13X4 1/2	50	27.96
5080CSP	44250	1/2-13X5	50	30.26
5088CSP	44252	1/2-13X5 1/2	50	33.26
5096CSP	44254	1/2-13X6	50	36.36
50104CSP	44256	1/2-13X6 1/2	10	39.70
50112CSP	44258	1/2-13X7	10	42.60
50128CSP	44260	1/2-13X8	10	48.00
6216CSP	44262	5/8-11X1	50	16.40
6220CSP	44264	5/8-11X1 1/4	50	18.20
6224CSP	44266	5/8-11X1 1/2	50	19.74
6228CSP	44268	5/8-11X1 3/4	50	21.64
6232CSP	44270	5/8-11X2	50	23.60
6236CSP	44272	5/8-11X2 1/4	25	25.52
6240CSP	44274	5/8-11X2 1/2	25	27.80
6244CSP	44276	5/8-11X2 3/4	25	29.68
6248CSP	44278	5/8-11X3	25	31.46
6252CSP	44280	5/8-11X3 1/4	25	32.80
6256CSP	44282	5/8-11X3 1/2	25	35.43
6260CSP	64350	5/8-11X3 3/4	25	38.12
6264CSP	44284	5/8-11X4	25	40.80
6272CSP	44286	5/8-11X4 1/2	25	44.16
6280CSP	44288	5/8-11X5	25	49.60
6288CSP	44290	5/8-11X5 1/2	25	54.28
6296CSP	44292	5/8-11X6	10	59.00
62104CSP	44294	5/8-11X6 1/2	10	63.00
62112CSP	44296	5/8-11X7	10	68.00
62128CSP	44298	5/8-11X8	10	76.00
7520CSP	44300	3/4-10X1 1/4	25	29.20
7524CSP	44302	3/4-10X1 1/2	25	31.26
7528CSP	44304	3/4-10X1 3/4	25	34.48
7532CSP	44306	3/4-10X2	25	37.80
7536CSP	44308	3/4-10X2 1/4	25	39.36
7540CSP	44310	3/4-10X2 1/2	25	42.16
7544CSP	44312	3/4-10X2 3/4	25	44.80

More sizes on next column

**BLUE DEVIL® BRAND SOCKET HEAD
CAP SCREWS / U.N.R.C. COARSE THREAD**

All Items are Made in the U.S.A.
Manufactured to ASME B18.3 specifications
Class 3A Threads / Black Oxide Finish

Kanebridge Part #	Blue Devil® Number	Size	Ctn Qty	Wght Lbs/C
7548CSP	44314	3/4-10X3	25	48.90
7552CSP	44316	3/4-10X3 1/4	25	50.88
7556CSP	44318	3/4-10X3 1/2	25	54.40
7560CSP	64380	3/4-10X3 3/4	25	58.00
7564CSP	44320	3/4-10X4	25	61.16
7572CSP	44322	3/4-10X4 1/2	25	66.12
7580CSP	44324	3/4-10X5	25	73.32
7588CSP	44326	3/4-10X5 1/2	25	78.64
7596CSP	44328	3/4-10X6	10	86.80
75104CSP	44330	3/4-10X6 1/2	10	91.50
75112CSP	44332	3/4-10X7	10	99.50
75128CSP	44334	3/4-10X8	10	112.00
8732CSP	44336	7/8-9X2	10	53.70
8736CSP	44338	7/8-9X2 1/4	10	57.50
8740CSP	44340	7/8-9X2 1/2	10	61.00
8744CSP	44342	7/8-9X2 3/4	10	65.00
8748CSP	44344	7/8-9X3	10	67.70
8752CSP	44346	7/8-9X3 1/4	10	74.00
8756CSP	44348	7/8-9X3 1/2	10	76.50
8764CSP	44350	7/8-9X4	10	83.50
8772CSP	44352	7/8-9X4 1/2	10	93.60
8780CSP	44354	7/8-9X5	10	100.50
8788CSP	44356	7/8-9X5 1/2	10	113.00
8796CSP	44358	7/8-9X6	10	120.00
87104CSP	44360	7/8-9X6 1/2	10	129.00
87112CSP	44362	7/8-9X7	10	138.00
87128CSP	44364	7/8-9X8	10	155.00
10032CSP	44366	1-8X2	10	71.20
10036CSP	44368	1-8X2 1/4	10	76.00
10040CSP	44370	1-8X2 1/2	10	83.50
10044CSP	44372	1-8X2 3/4	10	92.30
10048CSP	44374	1-8X3	10	95.80
10052CSP	44376	1-8X3 1/4	10	100.90
10056CSP	44378	1-8X3 1/2	10	108.50
10064CSP	44380	1-8X4	10	115.40
10072CSP	44382	1-8X4 1/2	10	128.40
10080CSP	44384	1-8X5	10	139.00
10088CSP	44386	1-8X5 1/2	10	154.00
10096CSP	44388	1-8X6	10	161.50
100104CSP	44390	1-8X6 1/2	10	176.00
100112CSP	44392	1-8X7	10	187.00
100128CSP	44394	1-8X8	10	209.00
12540CSP	44396	1 1/4-7X2 1/2	1	150.00
12548CSP	44398	1 1/4-7X3	1	160.00
12556CSP	44400	1 1/4-7X3 1/2	1	180.00
12564CSP	44402	1 1/4-7X4	1	200.00
12572CSP	44404	1 1/4-7X4 1/2	1	210.00
12580CSP	44406	1 1/4-7X5	1	230.00
12588CSP	44408	1 1/4-7X5 1/2	1	240.00
12596CSP	44410	1 1/4-7X6	1	260.00
125104CSP	44412	1 1/4-7X6 1/2	1	280.00
125112CSP	44414	1 1/4-7X7	1	290.00
125128CSP	44416	1 1/4-7X8	1	330.00
125144CSP	44418	1 1/4-7X9	1	360.00
125160CSP	44420	1 1/4-7X10	1	390.00
15048CSP	44424	1 1/2-6X3	1	240.00
15056CSP	44426	1 1/2-6X3 1/2	1	250.00
15064CSP	44428	1 1/2-6X4	1	290.00
15072CSP	44430	1 1/2-6X4 1/2	1	300.00
15080CSP	44432	1 1/2-6X5	1	330.00
15088CSP	44434	1 1/2-6X5 1/2	1	350.00
15096CSP	44436	1 1/2-6X6	1	380.00
150104CSP	44438	1 1/2-6X6 1/2	1	400.00
150112CSP	44440	1 1/2-6X7	1	430.00

More sizes on on page 347

Alloy Steel with
Black Oxide Finish



Free Manufacturer's
Certifications Available

**BLUE DEVIL® BRAND SOCKET HEAD
CAP SCREWS / U.N.R.C. COARSE THREAD**

All Items are Made in the U.S.A.
Manufactured to ASME B18.3 specifications
Class 3A Threads / Black Oxide Finish

Kanebridge Part #	Blue Devil® Number	Size	Ctn Qty	Wght Lbs/C
150128CSP	44442	1 1/2-6X8	1	480.00
150144CSP	44444	1 1/2-6X9	1	520.00
150160CSP	44446	1 1/2-6X10	1	560.00
150192CSP	44448	1 1/2-6X12	1	650.00

Alloy Steel with
Black Oxide Finish

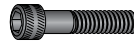

Free Manufacturer's
Certifications Available

**BLUE DEVIL® BRAND SOCKET HEAD
CAP SCREWS / U.N.R.F. FINE THREAD**

All Items are Made in the U.S.A.
Manufactured to ASME B18.3 specifications
Class 3A Threads / Black Oxide Finish

Kanebridge Part #	Blue Devil® Number	Size	Ctn Qty	Wght Lbs/C
-00F02CSP	45001	0-80X1/8	100	0.03
-00F04CSP	45005	0-80X1/4	100	0.05
-00F06CSP	45007	0-80X3/8	100	0.05
01F03CSP	45011	1-72X3/16	100	0.05
01F06CSP	45015	1-72X3/8	100	0.07
06F04CSP	45017	6-40X1/4	100	0.22
06F06CSP	45019	6-40X3/8	100	0.26
06F08CSP	45021	6-40X1/2	100	0.30
06F10CSP	45023	6-40X5/8	100	0.34
06F12CSP	45025	6-40X3/4	100	0.40
08F06CSP	45027	8-36X3/8	100	0.38
08F08CSP	45029	8-36X1/2	100	0.46
08F12CSP	45031	8-36X3/4	100	0.58
1104CSP	64540	10-32X1/4	100	0.49
1105CSP	64542	10-32X5/16	100	0.53
1106CSP	45033	10-32X3/8	100	0.52
1108CSP	45035	10-32X1/2	100	0.60
1110CSP	45037	10-32X5/8	100	0.68
1112CSP	45039	10-32X3/4	100	0.76
1114CSP	45041	10-32X7/8	100	0.85
1116CSP	45043	10-32X1	100	0.96
1120CSP	45045	10-32X1 1/4	100	1.17
1124CSP	45047	10-32X1 1/2	100	1.33
1128CSP	45049	10-32X1 3/4	100	1.55
1132CSP	45051	10-32X2	100	1.73
1136CSP	84101	10-32X2 1/4	100	1.94
1140CSP	84102	10-32X2 1/2	100	2.10
1148CSP	84104	10-32X3	100	2.56
1506CSP	45053	1/4-28X3/8	100	1.04
1508CSP	45055	1/4-28X1/2	100	1.18
1510CSP	45057	1/4-28X5/8	100	1.30
1512CSP	45059	1/4-28X3/4	100	1.46
1514CSP	45061	1/4-28X7/8	100	1.60
1516CSP	45063	1/4-28X1	100	1.79
1520CSP	45065	1/4-28X1 1/4	100	2.03
1524CSP	45067	1/4-28X1 1/2	100	2.50
1528CSP	45069	1/4-28X1 3/4	100	2.80
1532CSP	45071	1/4-28X2	100	3.18
1536CSP	45073	1/4-28X2 1/4	100	3.39
1540CSP	64570	1/4-28X2 1/2	100	3.70

More sizes on next column

Alloy Steel with
Black Oxide Finish



Free Manufacturer's
Certifications Available

**BLUE DEVIL® BRAND SOCKET HEAD
CAP SCREWS / U.N.R.F. FINE THREAD**

All Items are Made in the U.S.A.
Manufactured to ASME B18.3 specifications
Class 3A Threads / Black Oxide Finish

Kanebridge Part #	Blue Devil® Number	Size	Ctn Qty	Wght Lbs/C
3208CSP	45077	5/16-24X1/2	100	2.10
3210CSP	45079	5/16-24X5/8	100	2.24
3212CSP	45081	5/16-24X3/4	100	2.51
3214CSP	45083	5/16-24X7/8	100	2.72
3216CSP	45085	5/16-24X1	100	2.96
3220CSP	45087	5/16-24X1 1/4	100	3.40
3224CSP	45089	5/16-24X1 1/2	100	3.90
3228CSP	45091	5/16-24X1 3/4	100	4.41
3232CSP	45093	5/16-24X2	100	4.90
3236CSP	45095	5/16-24X2 1/4	100	5.61
3240CSP	45097	5/16-24X2 1/2	100	6.08
3244CSP	64590	5/16-24X2 3/4	100	6.40
3808CSP	45099	3/8-24X1/2	100	3.30
3810CSP	45101	3/8-24X5/8	100	3.60
3812CSP	45103	3/8-24X3/4	100	3.90
3814CSP	45105	3/8-24X7/8	100	4.24
3816CSP	45107	3/8-24X1	100	4.53
3820CSP	45109	3/8-24X1 1/4	100	5.40
3824CSP	45111	3/8-24X1 1/2	100	5.97
3828CSP	45113	3/8-24X1 3/4	100	6.76
3832CSP	45115	3/8-24X2	100	7.50
3836CSP	45117	3/8-24X2 1/4	100	8.30
3840CSP	45119	3/8-24X2 1/2	50	9.12
3848CSP	45121	3/8-24X3	50	10.80
3856CSP	64610	3/8-24X3 1/2	50	12.30
4416CSP	45123	7/16-20X1	100	6.65
4420CSP	45125	7/16-20X1 1/4	100	7.65
4424CSP	45127	7/16-20X1 1/2	100	8.55
4428CSP	64630	7/16-20X1 3/4	50	9.20
4432CSP	45129	7/16-20X2	50	10.61
4440CSP	64634	7/16-20X2 1/2	50	12.00
5116CSP	45131	1/2-20X1	100	9.70
5120CSP	45133	1/2-20X1 1/4	100	10.52
5124CSP	45135	1/2-20X1 1/2	100	12.13
5128CSP	45137	1/2-20X1 3/4	50	13.20
5132CSP	45139	1/2-20X2	50	14.80
5136CSP	45141	1/2-20X2 1/4	50	16.31
5140CSP	45143	1/2-20X2 1/2	50	17.52
5148CSP	45145	1/2-20X3	50	20.40
6316CSP	45147	5/8-18X1	50	17.00
6320CSP	45149	5/8-18X1 1/4	50	19.20
6324CSP	45151	5/8-18X1 1/2	50	21.00
6328CSP	45153	5/8-18X1 3/4	50	22.82
6332CSP	45155	5/8-18X2	50	25.00
6336CSP		5/8-18X2 1/4	25	27.20
6340CSP	45157	5/8-18X2 1/2	25	29.60
7648CSP		3/4-16X3	25	48.00

We package Blue Devil®
Sockets in boxes with Steel
re-inforced corners (see picture
on pg. 362)

Stainless Steel
Not Heat Treated

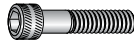

Free Manufacturer's
Certifications Available

**BLUE DEVIL® BRAND SOCKET HEAD
CAP SCREWS / U.N.R.C. COARSE THREAD**

All Items are Made in the U.S.A.
Manufactured to ASME B18.3 specifications
Class 3A Threads

Kanebridge Part #	Blue Devil® Number	Size	Ctn Qty	Wght Lbs/C
0203CSSS	26000	2-56X3/16	100	0.06
0204CSSS	26002	2-56X1/4	100	0.07
0206CSSS	26004	2-56X3/8	100	0.09
0208CSSS	26006	2-56X1/2	100	0.11
0403CSSS	62102	4-40X3/16	100	0.10
0404CSSS	26016	4-40X1/4	100	0.13
0405CSSS	62104	4-40X5/16	100	0.14
0406CSSS	26018	4-40X3/8	100	0.15
0408CSSS	26020	4-40X1/2	100	0.18
0410CSSS	62110	4-40X5/8	100	0.20
0412CSSS	62114	4-40X3/4	100	0.30
0416CSSS	62118	4-40X1	100	0.40
0604CSSS	26022	6-32X1/4	100	0.21
0605CSSS		6-32X5/16	100	0.23
0606CSSS	26024	6-32X3/8	100	0.25
0608CSSS	26026	6-32X1/2	100	0.29
0610CSSS	26028	6-32X5/8	100	0.33
0612CSSS	26030	6-32X3/4	100	0.36
0620CSSS	62144	6-32X1 1/4	100	0.60
0804CSSS	62158	8-32X1/4	100	0.33
0806CSSS	26032	8-32X3/8	100	0.38
0808CSSS	26034	8-32X1/2	100	0.45
0810CSSS	26036	8-32X5/8	100	0.53
0812CSSS	26038	8-32X3/4	100	0.57
0816CSSS	26040	8-32X1	100	0.69
0820CSSS	62170	8-32X1 1/4	100	0.80
0824CSSS	62172	8-32X1 1/2	100	0.95
1006CSSS	26042	10-24X3/8	100	0.57
1008CSSS	26044	10-24X1/2	100	0.63
1010CSSS	26046	10-24X5/8	100	0.71
1012CSSS	26048	10-24X3/4	100	0.78
1014CSSS	26050	10-24X7/8	100	0.87
1016CSSS	26052	10-24X1	100	0.94
1020CSSS	26054	10-24X1 1/4	100	1.11
1024CSSS	26056	10-24X1 1/2	100	1.28
1404CSSS	62200	1/4-20X1/4	100	0.95
1406CSSS	26058	1/4-20X3/8	100	1.01
1408CSSS	26060	1/4-20X1/2	100	1.13
1410CSSS	26062	1/4-20X5/8	100	1.27
1412CSSS	26064	1/4-20X3/4	100	1.39
1414CSSS	26066	1/4-20X7/8	100	1.55
1416CSSS	26068	1/4-20X1	100	1.67
1420CSSS	26070	1/4-20X1 1/4	100	1.94
1424CSSS	26072	1/4-20X1 1/2	100	2.42
1428CSSS	26074	1/4-20X1 3/4	100	2.65
1432CSSS	26076	1/4-20X2	100	3.00
1436CSSS	62230	1/4-20X2 1/4	50	3.40
1440CSSS	62234	1/4-20X2 1/2	50	3.80
3108CSSS	26080	5/16-18X1/2	100	2.00
3112CSSS	26084	5/16-18X3/4	100	2.45
3114CSSS	26086	5/16-18X7/8	100	2.70
3116CSSS	26088	5/16-18X1	100	2.86
3120CSSS	26090	5/16-18X1 1/4	100	3.30
3124CSSS	26092	5/16-18X1 1/2	100	3.79
3132CSSS	26096	5/16-18X2	100	4.90
3136CSSS	62260	5/16-18X2 1/4	50	5.40
3164CSSS	62270	5/16-18X4	50	9.20
3708CSSS	26098	3/8-16X1/2	100	3.17
3710CSSS	26100	3/8-16X5/8	100	3.48
3712CSSS	26102	3/8-16X3/4	100	3.83
3716CSSS	26106	3/8-16X1	100	4.57
3720CSSS	26108	3/8-16X1 1/4	100	5.15

More sizes on next column

Stainless Steel
Not Heat Treated



Free Manufacturer's
Certifications Available

**BLUE DEVIL® BRAND SOCKET HEAD
CAP SCREWS / U.N.R.C. COARSE THREAD**

All Items are Made in the U.S.A.
Manufactured to ASME B18.3 specifications
Class 3A Threads

Kanebridge Part #	Blue Devil® Number	Size	Ctn Qty	Wght Lbs/C
3724CSSS	26110	3/8-16X1 1/2	100	5.75
3728CSSS	26112	3/8-16X1 3/4	100	6.60
3732CSSS	26114	3/8-16X2	100	7.80
3736CSSS	62880	3/8-16X2 1/4	50	8.60
3740CSSS	26116	3/8-16X2 1/2	50	8.94
3748CSSS	62290	3/8-16X3	50	10.20
5016CSSS	26120	1/2-13X1	100	9.60
5020CSSS	26122	1/2-13X1 1/4	100	10.61
5024CSSS	26124	1/2-13X1 1/2	100	11.67
5028CSSS	26126	1/2-13X1 3/4	50	12.88

Stainless Steel
Not Heat Treated



Free Manufacturer's
Certifications Available

**BLUE DEVIL® BRAND SOCKET HEAD
CAP SCREWS / U.N.R.F. FINE THREAD**

All Items are Made in the U.S.A.
Manufactured to ASME B18.3 specifications
Class 3A Threads

Kanebridge Part #	Blue Devil® Number	Size	Ctn Qty	Wght Lbs/C
1104CSSS	62500	10-32X1/4	100	0.55
1106CSSS	27017	10-32X3/8	100	0.57
1108CSSS	27019	10-32X1/2	100	0.67
1110CSSS	27021	10-32X5/8	100	0.74
1112CSSS	27023	10-32X3/4	100	0.82
1114CSSS	27025	10-32X7/8	100	0.90
1116CSSS	27027	10-32X1	100	0.98
1120CSSS	27029	10-32X1 1/4	100	1.18
1124CSSS	27031	10-32X1 1/2	100	1.34
1136CSSS	62520	10-32X2 1/4	100	1.90
1508CSSS	27033	1/4-28X1/2	100	1.17
1512CSSS	27037	1/4-28X3/4	100	1.50
1516CSSS	27039	1/4-28X1	100	1.80
3816CSSS	27051	3/8-24X1	100	4.60

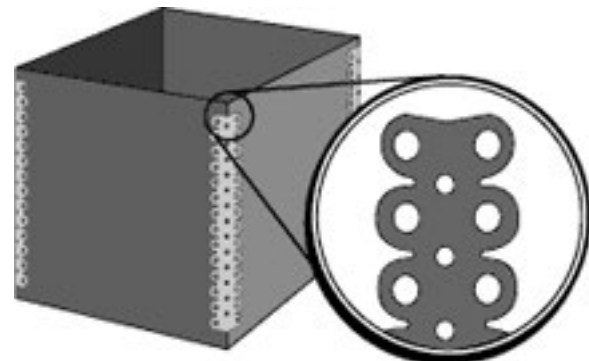

Blue Devil® box design

Heat Treated Alloy Steel

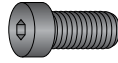

Free Manufacturer's Certifications Available

BLUE DEVIL® BRAND LOW HEAD
SOCKET CAP SCREWS / COARSE & FINE THREAD

All Items are Made in the U.S.A.
Class 3A Threads / Black Oxide Finish

Kanebridge Part #	Blue Devil® Number	Size	Ctn Qty	Wght Lbs/C
0806CSL	18000	8-32X3/8	100	0.30
0808CSL	18002	8-32X1/2	100	0.35
0810CSL	18004	8-32X5/8	100	0.44
0812CSL	18006	8-32X3/4	100	0.50
0816CSL	18008	8-32X1	100	0.60
1006CSL	18010	10-24X3/8	100	0.42
1008CSL	18012	10-24X1/2	100	0.50
1010CSL	18014	10-24X5/8	100	0.57
1012CSL	18016	10-24X3/4	100	0.65
1016CSL	18018	10-24X1	100	0.79
1106CSL	18213	10-32X3/8	100	0.41
1108CSL	18219	10-32X1/2	100	0.51
1110CSL	18223	10-32X5/8	100	0.60
1112CSL	18227	10-32X3/4	100	0.67
1406CSL	18020	1/4-20X3/8	100	0.74
1408CSL	18022	1/4-20X1/2	100	0.86
1410CSL	18024	1/4-20X5/8	100	1.01
1412CSL	18026	1/4-20X3/4	100	1.13
1416CSL	18028	1/4-20X1	100	1.38
3108CSL	18030	5/16-18X1/2	100	1.40
3112CSL	18032	5/16-18X3/4	100	1.82
3116CSL	18034	5/16-18X1	100	2.26
3120CSL	18036	5/16-18X1 1/4	100	2.68
3124CSL	18038	5/16-18X1 1/2	100	3.07
3708CSL	18040	3/8-16X1/2	100	2.30
3712CSL	18042	3/8-16X3/4	100	3.02
3716CSL	18044	3/8-16X1	100	3.60
3720CSL	18046	3/8-16X1 1/4	100	4.19
3724CSL	18048	3/8-16X1 1/2	100	4.96
5016CSL	18050	1/2-13X1	50	7.40
5020CSL	18052	1/2-13X1 1/4	50	8.12
5024CSL	18054	1/2-13X1 1/2	50	9.31

Alloy Steel with Black Oxide Finish

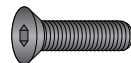

Free Manufacturer's Certifications Available

BLUE DEVIL® BRAND FLAT HEAD
SOCKET CAP SCREWS / U.N.R.C. COARSE THREAD

All Items are Made in the U.S.A.
Manufactured to ASME B18.3 specifications
Class 3A Threads / Black Oxide Finish

Kanebridge Part #	Blue Devil® Number	Size	Ctn Qty	Wght Lbs/C
-003CSFL		0-80X3/16	100	0.04
0404CSFL	19000	4-40X1/4	100	0.10
0406CSFL	19002	4-40X3/8	100	0.12
0408CSFL	19004	4-40X1/2	100	0.15
0410CSFL	19006	4-40X5/8	100	0.19
0412CSFL	19008	4-40X3/4	100	0.20
0504CSFL	19010	5-40X1/4	100	0.12
0506CSFL	19012	5-40X3/8	100	0.15
0508CSFL	19014	5-40X1/2	100	0.18
0510CSFL	19016	5-40X5/8	100	0.23
0512CSFL	19018	5-40X3/4	100	0.26

More sizes on next column

Alloy Steel with Black Oxide Finish

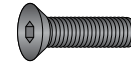

Free Manufacturer's Certifications Available

BLUE DEVIL® BRAND FLAT HEAD
SOCKET CAP SCREWS / U.N.R.C. COARSE THREAD

All Items are Made in the U.S.A.
Manufactured to ASME B18.3 specifications
Class 3A Threads / Black Oxide Finish

Kanebridge Part #	Blue Devil® Number	Size	Ctn Qty	Wght Lbs/C
0604CSFL	19020	6-32X1/4	100	0.15
0606CSFL	19022	6-32X3/8	100	0.19
0608CSFL	19024	6-32X1/2	100	0.24
0610CSFL	19026	6-32X5/8	100	0.29
0612CSFL	19028	6-32X3/4	100	0.31
0616CSFL		6-32X1	100	0.40
0806CSFL	19030	8-32X3/8	100	0.29
0808CSFL	19032	8-32X1/2	100	0.34
0810CSFL	19034	8-32X5/8	100	0.38
0812CSFL	19036	8-32X3/4	100	0.48
0816CSFL	19038	8-32X1	100	0.58
1006CSFL	19040	10-24X3/8	100	0.37
1008CSFL	19042	10-24X1/2	100	0.48
1010CSFL	19044	10-24X5/8	100	0.54
1012CSFL	19046	10-24X3/4	100	0.60
1016CSFL	19048	10-24X1	100	0.74
1020CSFL	19050	10-24X1 1/4	100	0.87
1024CSFL	19052	10-24X1 1/2	100	1.20
1406CSFL	19054	1/4-20X3/8	100	0.71
1408CSFL	19056	1/4-20X1/2	100	0.83
1410CSFL	19058	1/4-20X5/8	100	0.97
1412CSFL	19060	1/4-20X3/4	100	1.07
1416CSFL	19062	1/4-20X1	100	1.40
1420CSFL	19064	1/4-20X1 1/4	100	1.62
1424CSFL	19066	1/4-20X1 1/2	100	1.90
1428CSFL	19068	1/4-20X1 3/4	100	2.34
1432CSFL	19070	1/4-20X2	100	2.60
3108CSFL	19072	5/16-18X1/2	100	1.40
3110CSFL	19074	5/16-18X5/8	100	1.60
3112CSFL	19076	5/16-18X3/4	100	1.82
3116CSFL	19078	5/16-18X1	100	2.22
3120CSFL	19080	5/16-18X1 1/4	100	2.70
3124CSFL	19082	5/16-18X1 1/2	100	3.10
3128CSFL	19084	5/16-18X1 3/4	100	3.50
3132CSFL	19086	5/16-18X2	100	4.30
3136CSFL	19088	5/16-18X2 1/4	100	4.70
3140CSFL	19090	5/16-18X2 1/2	100	5.33
3708CSFL	19092	3/8-16X1/2	100	2.25
3710CSFL	19094	3/8-16X5/8	100	2.50
3712CSFL	19096	3/8-16X3/4	100	2.82
3714CSFL	66090	3/8-16X7/8	100	3.30
3716CSFL	19098	3/8-16X1	100	3.51
3720CSFL	19100	3/8-16X1 1/4	100	4.01
3724CSFL	19102	3/8-16X1 1/2	100	4.72
3728CSFL	19104	3/8-16X1 3/4	100	5.25
3732CSFL	19106	3/8-16X2	100	5.88
3736CSFL	19108	3/8-16X2 1/4	100	6.90
3740CSFL	19110	3/8-16X2 1/2	50	7.60
3748CSFL	19112	3/8-16X3	50	9.20
4312CSFL	19114	7/16-14X3/4	100	3.50
4316CSFL	19116	7/16-14X1	100	4.30
4320CSFL	19118	7/16-14X1 1/4	100	5.14
4324CSFL	19120	7/16-14X1 1/2	100	5.30
5012CSFL	19122	1/2-13X3/4	100	4.50
5016CSFL	19124	1/2-13X1	100	5.70
5020CSFL	19126	1/2-13X1 1/4	100	6.80
5024CSFL	19128	1/2-13X1 1/2	100	8.00
5028CSFL	19130	1/2-13X1 3/4	50	9.20
5032CSFL	19132	1/2-13X2	50	10.58
5036CSFL	19134	1/2-13X2 1/4	50	11.56

More sizes on page 350

Alloy Steel with
Black Oxide Finish

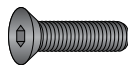

Free Manufacturer's
Certifications Available

**BLUE DEVIL® BRAND FLAT HEAD
SOCKET CAP SCREWS / U.N.R.C. COARSE THREAD**

All Items are Made in the U.S.A.
Manufactured to ASME B18.3 specifications
Class 3A Threads / Black Oxide Finish

Kanebridge Part #	Blue Devil® Number	Size	Ctn Qty	Wght Lbs/C
5040CSFL	19136	1/2-13X2 1/2	50	13.00
5048CSFL	19138	1/2-13X3	50	15.12
5064CSFL	66110	1/2-13X4	25	21.02
5080CSFL	66120	1/2-13X5	25	25.20
6220CSFL	19140	5/8-11X1 1/4	50	11.80
6224CSFL	19142	5/8-11X1 1/2	50	13.20
6228CSFL	19144	5/8-11X1 3/4	50	15.40
6232CSFL	19146	5/8-11X2	50	17.00
6236CSFL	19148	5/8-11X2 1/4	25	19.60
6240CSFL	19150	5/8-11X2 1/2	25	20.80
6248CSFL	19152	5/8-11X3	25	24.38
7524CSFL	19156	3/4-10X1 1/2	25	21.00
7528CSFL	19158	3/4-10X1 3/4	25	23.50
7532CSFL	19160	3/4-10X2	25	26.00
7536CSFL	19162	3/4-10X2 1/4	25	28.80
7540CSFL	19164	3/4-10X2 1/2	25	30.80
7548CSFL	19166	3/4-10X3	25	36.28

Alloy Steel with
Black Oxide Finish

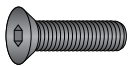

Free Manufacturer's
Certifications Available

**BLUE DEVIL® BRAND FLAT HEAD
SOCKET CAP SCREWS / U.N.R.F. FINE THREAD**

All Items are Made in the U.S.A.
Manufactured to ASME B18.3 specifications
Class 3A Threads / Black Oxide Finish

Kanebridge Part #	Blue Devil® Number	Size	Ctn Qty	Wght Lbs/C
1106CSFL	19201	10-32X3/8	100	0.37
1108CSFL	19203	10-32X1/2	100	0.50
1110CSFL	19205	10-32X5/8	100	0.55
1112CSFL	19207	10-32X3/4	100	0.61
1116CSFL	19209	10-32X1	100	0.78
1120CSFL	19211	10-32X1 1/4	100	0.94
1124CSFL	19213	10-32X1 1/2	100	1.10
1132CSFL	66410	10-32X2	100	1.54
1506CSFL	19215	1/4-28X3/8	100	0.70
1508CSFL	19217	1/4-28X1/2	100	0.83
1510CSFL	19219	1/4-28X5/8	100	1.00
1512CSFL	19221	1/4-28X3/4	100	1.20
1514CSFL	66420	1/4-28X7/8	100	1.23
1516CSFL	19223	1/4-28X1	100	1.40
1520CSFL	19225	1/4-28X1 1/4	100	1.72
1524CSFL	19227	1/4-28X1 1/2	100	2.00
3208CSFL	19229	5/16-24X1/2	100	1.40
3210CSFL	19231	5/16-24X5/8	100	1.64
3212CSFL	19233	5/16-24X3/4	100	1.81
3216CSFL	19235	5/16-24X1	100	2.31
3220CSFL	19237	5/16-24X1 1/4	100	2.66
3810CSFL	19239	3/8-24X5/8	100	2.54
3812CSFL	19241	3/8-24X3/4	100	2.88
3816CSFL	19243	3/8-24X1	100	3.60
3820CSFL	19245	3/8-24X1 1/4	100	4.14
3824CSFL	19247	3/8-24X1 1/2	100	4.87
4416CSFL	66100	7/16-20X1	100	4.60
5112CSFL	19249	1/2-20X3/4	100	4.70
5116CSFL	19251	1/2-20X1	100	6.01

More sizes on next column

Alloy Steel with
Black Oxide Finish

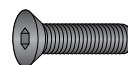

Free Manufacturer's
Certifications Available

**BLUE DEVIL® BRAND FLAT HEAD
SOCKET CAP SCREWS / U.N.R.F. FINE THREAD**

All Items are Made in the U.S.A.
Manufactured to ASME B18.3 specifications
Class 3A Threads / Black Oxide Finish

Kanebridge Part #	Blue Devil® Number	Size	Ctn Qty	Wght Lbs/C
5120CSFL	19253	1/2-20X1 1/4	100	7.03
5124CSFL	19255	1/2-20X1 1/2	100	8.41
5128CSFL	19257	1/2-20X1 3/4	50	10.00
5132CSFL	19259	1/2-20X2	50	10.80

Alloy Steel w/
Black Oxide finish

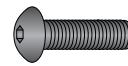

Free Manufacturer's
Certifications Available

**BLUE DEVIL® BRAND BUTTON HEAD
SOCKET CAP SCREWS / U.N.R.C. COARSE THREAD**

All Items are Made in the U.S.A.
Manufactured to ASME B18.3 specifications
Class 3A Threads / Black Oxide Finish

Kanebridge Part #	Blue Devil® Number	Size	Ctn Qty	Wght Lbs/C
0403CSB	67010	4-40X3/16	100	0.09
0404CSB	20000	4-40X1/4	100	0.11
0406CSB	20002	4-40X3/8	100	0.12
0408CSB	20004	4-40X1/2	100	0.15
0412CSB	67020	4-40X3/4	100	0.20
0604CSB	20006	6-32X1/4	100	0.15
0606CSB	20008	6-32X3/8	100	0.19
0608CSB	20010	6-32X1/2	100	0.23
0610CSB	20012	6-32X5/8	100	0.27
0612CSB	67030	6-32X3/4	100	0.30
0616CSB	67040	6-32X1	100	0.41
0804CSB	20014	8-32X1/4	100	0.24
0806CSB	20016	8-32X3/8	100	0.29
0808CSB	20018	8-32X1/2	100	0.34
0810CSB	20020	8-32X5/8	100	0.41
0812CSB	20022	8-32X3/4	100	0.48
0816CSB	67050	8-32X1	100	0.60
0820CSB	67060	8-32X1 1/4	100	0.73
1004CSB	20024	10-24X1/4	100	0.31
1006CSB	20026	10-24X3/8	100	0.39
1008CSB	20028	10-24X1/2	100	0.49
1010CSB	20030	10-24X5/8	100	0.58
1012CSB	20032	10-24X3/4	100	0.63
1014CSB	20034	10-24X7/8	100	0.70
1016CSB	20036	10-24X1	100	0.79
1024CSB	67070	10-24X1 1/2	100	1.10
1404CSB	67080	1/4-20X1/4	100	0.50
1406CSB	20038	1/4-20X3/8	100	0.73
1408CSB	20040	1/4-20X1/2	100	0.85
1410CSB	20042	1/4-20X5/8	100	0.96
1412CSB	20044	1/4-20X3/4	100	1.12
1414CSB	20046	1/4-20X7/8	100	1.30
1416CSB	20048	1/4-20X1	100	1.39
1420CSB	67090	1/4-20X1 1/4	100	1.60
1432CSB		1/4-20X2	100	2.50
1436CSB	67110	1/4-20X2 1/4	100	2.70
3106CSB		5/16-18X3/8	100	1.30
3108CSB	20052	5/16-18X1/2	100	1.48
3110CSB	20054	5/16-18X5/8	100	1.70
3112CSB	20056	5/16-18X3/4	100	1.91
3114CSB	20058	5/16-18X7/8	100	2.20
3116CSB	20060	5/16-18X1	100	2.40
3120CSB	67120	5/16-18X1 1/4	100	2.80
3136CSB	67130	5/16-18X2 1/4	100	4.50

More sizes on page 351

Alloy Steel w/
Black Oxide finish

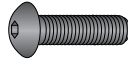

Free Manufacturer's
Certifications Available

BLUE DEVIL® BRAND BUTTON HEAD
SOCKET CAP SCREWS / U.N.R.C. COARSE THREAD

All Items are Made in the U.S.A.
Manufactured to ASME B18.3 specifications
Class 3A Threads / Black Oxide Finish

Kanebridge Part #	Blue Devil® Number	Size	Ctn Qty	Wght Lbs/C
3708CSB	20062	3/8-16X1/2	100	2.30
3710CSB	20064	3/8-16X5/8	100	2.70
3712CSB	20066	3/8-16X3/4	100	2.96
3714CSB	20068	3/8-16X7/8	100	3.30
3716CSB	20070	3/8-16X1	100	3.57
3720CSB	20072	3/8-16X1 1/4	100	4.22
3724CSB	67140	3/8-16X1 1/2	100	4.90
5012CSB	67150	1/2-13X3/4	50	5.00
5016CSB	20074	1/2-13X1	100	7.20
5020CSB	20076	1/2-13X1 1/4	100	8.10
5024CSB	20078	1/2-13X1 1/2	100	9.57
5032CSB	20080	1/2-13X2	100	11.80
5048CSB	67170	1/2-13X3	50	17.60
6216CSB	20082	5/8-11X1	50	11.45
6220CSB	20084	5/8-11X1 1/4	50	13.00
6224CSB	20086	5/8-11X1 1/2	50	15.20
6232CSB	20088	5/8-11X2	50	18.72

Alloy Steel w/
Black Oxide finish

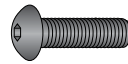

Free Manufacturer's
Certifications Available

BLUE DEVIL® BRAND BUTTON HEAD
SOCKET CAP SCREWS / U.N.R.F. FINE THREAD

All Items are Made in the U.S.A.
Manufactured to ASME B18.3 specifications
Class 3A Threads / Black Oxide Finish

Kanebridge Part #	Blue Devil® Number	Size	Ctn Qty	Wght Lbs/C
1104CSB	20201	10-32X1/4	100	0.33
1106CSB	20203	10-32X3/8	100	0.41
1108CSB	20205	10-32X1/2	100	0.51
1110CSB	20207	10-32X5/8	100	0.60
1112CSB	20209	10-32X3/4	100	0.67
1114CSB	20211	10-32X7/8	100	0.76
1116CSB	20213	10-32X1	100	0.83
1120CSB		10-32X1 1/4	100	0.90
1504CSB	67440	1/4-28X1/4	100	0.54
1506CSB	20215	1/4-28X3/8	100	0.77
1508CSB	20217	1/4-28X1/2	100	0.90
1510CSB	20219	1/4-28X5/8	100	1.00
1512CSB	20221	1/4-28X3/4	100	1.10
1516CSB	20223	1/4-28X1	100	1.50
3206CSB	20225	5/16-24X3/8	100	1.30
3208CSB	20227	5/16-24X1/2	100	1.40
3210CSB	20229	5/16-24X5/8	100	1.80
3212CSB	20231	5/16-24X3/4	100	2.01
3216CSB	20233	5/16-24X1	100	2.50
3816CSB	20237	3/8-24X1	100	3.90

Alloy Steel



Free Manufacturer's
Certifications Available

BLUE DEVIL® BRAND SOCKET
SHOULDER SCREWS / U.N.R.C. COARSE THREAD

All Items are Made in the U.S.A.
Manufactured to ASME B18.3 specifications
Class 3A Threads

Kanebridge Part #	Blue Devil® Number	Size	Ctn Qty	Wght Lbs/C
1/4" Diameter, 10-24 Threaded Size, 1/8 Key				
1406SS	13001	1/4X3/8	25	1.24
1408SS	13004	1/4X1/2	25	1.44
1410SS	13007	1/4X5/8	25	1.62
1412SS	13010	1/4X3/4	25	1.82
1416SS	13013	1/4X1	25	2.20
1420SS	13016	1/4X1 1/4	25	2.52
1424SS	13019	1/4X1 1/2	25	2.84
1432SS		1/4X2	25	3.20
5/16" Diameter, 1/4-20 Threaded Size, 5/32 Key				
3106SS	13022	5/16X3/8	25	1.60
3108SS	13025	5/16X1/2	25	2.40
3110SS	13028	5/16X5/8	25	2.80
3112SS	13031	5/16X3/4	25	3.20
3116SS	13034	5/16X1	25	3.60
3120SS	13037	5/16X1 1/4	25	4.00
3124SS	13040	5/16X1 1/2	25	4.40
3128SS	13043	5/16X1 3/4	25	5.20
3132SS	13046	5/16X2	25	5.60
3/8" Diameter, 5/16-18 Threaded Size, 3/16 Key				
3706SS	13049	3/8X3/8	25	3.56
3708SS	13052	3/8X1/2	25	3.92
3710SS	13055	3/8X5/8	25	4.30
3712SS	13058	3/8X3/4	25	4.80
3716SS	13061	3/8X1	25	5.44
3720SS	13064	3/8X1 1/4	25	6.24
3724SS	13067	3/8X1 1/2	25	7.06
3728SS	13070	3/8X1 3/4	25	7.84
3732SS	13073	3/8X2	25	8.80
3736SS	13076	3/8X2 1/4	25	9.40
3740SS	13079	3/8X2 1/2	25	10.20
3744SS	13082	3/8X2 3/4	25	10.80
3748SS	13085	3/8X3	25	11.60
3752SS	13088	3/8X3 1/4	25	12.80
3756SS	13091	3/8X3 1/2	25	13.20
3760SS	13092	3/8X3 3/4	25	14.00
3764SS	13097	3/8X4	25	14.80
1/2" Diameter, 3/8-16 Threaded Size, 1/4 Key				
5008SS	13100	1/2X1/2	25	7.60
5010SS	13103	1/2X5/8	25	8.28
5012SS	13106	1/2X3/4	25	9.20
5016SS	13109	1/2X1	25	10.40
5020SS	13112	1/2X1 1/4	25	11.60
5024SS	13115	1/2X1 1/2	25	13.44
5028SS	13118	1/2X1 3/4	25	14.56
5032SS	13121	1/2X2	25	16.40
5036SS	13124	1/2X2 1/4	25	18.00
5040SS	13127	1/2X2 1/2	25	18.72
5044SS	13130	1/2X2 3/4	25	20.00
5048SS	13133	1/2X3	25	21.40
5052SS	13136	1/2X3 1/4	25	22.80
5056SS	13139	1/2X3 1/2	25	24.40
5060SS	13140	1/2X3 3/4	25	26.00
5064SS	13145	1/2X4	25	27.60
5072SS	13151	1/2X4 1/2	10	30.00
5080SS	13157	1/2X5	10	34.00
5/8" Diameter, 1/2-13 Threaded Size, 5/16 Key				
6220SS	13160	5/8X1 1/4	25	20.00
6224SS	13163	5/8X1 1/2	25	22.00
6228SS	13166	5/8X1 3/4	25	24.80
6232SS	13169	5/8X2	25	26.00
6236SS	13172	5/8X2 1/4	25	28.00
6240SS	13175	5/8X2 1/2	25	30.24
6244SS	13178	5/8X2 3/4	25	32.80
6248SS	13181	5/8X3	25	34.80

More sizes on page 352

Alloy Steel

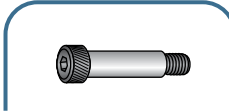

Free Manufacturer's
Certifications Available

BLUE DEVIL[®] BRAND SOCKET SHOULDER SCREWS / U.N.R.C. COARSE THREAD

All Items are Made in the U.S.A.
Manufactured to ASME B18.3 specifications
Class 3A Threads

Kanebridge Part #	Blue Devil [®] Number	Size	Ctn Qty	Wght Lbs/C
5/8" Diameter, 1/2-13 Threaded Size, 5/16 Key (continued)				
6252SS	13184	5/8X3 1/4	25	36.82
6256SS	13187	5/8X3 1/2	25	39.04
6260SS	13188	5/8X3 3/4	25	41.60
6264SS	13193	5/8X4	10	44.00
6272SS	13199	5/8X4 1/2	10	49.00
6280SS	13205	5/8X5	10	53.00
6288SS	13206	5/8X5 1/2	10	57.00
6296SS	13207	5/8X6	10	61.00
3/4" Diameter, 5/8-11 Threaded Size, 5/16 Key				
7524SS	13214	3/4X1 1/2	25	34.40
7528SS	13217	3/4X1 3/4	25	37.60
7532SS	13220	3/4X2	25	40.80
7536SS	13223	3/4X2 1/4	25	43.60
7540SS	13226	3/4X2 1/2	25	46.80
7544SS	13229	3/4X2 3/4	25	50.00
7548SS	13232	3/4X3	25	54.00
7552SS	13233	3/4X3 1/4	10	58.00
7556SS	13238	3/4X3 1/2	10	60.00
7560SS	13239	3/4X3 3/4	10	64.00
7564SS	13244	3/4X4	10	67.20
7572SS	13250	3/4X4 1/2	10	72.00
7580SS	13256	3/4X5	10	78.85
7588SS	13257	3/4X5 1/2	10	84.95
7596SS	13258	3/4X6	10	91.80

Alloy Steel with
Black Oxide Finish



Free Manufacturer's
Certifications Available

BLUE DEVIL[®] BRAND SOCKET SET SCREWS CUP POINT / U.N.C. COARSE THREAD

All Items are Made in the U.S.A.
Manufactured to ASME B18.3 specifications
Class 3A Threads / Black Oxide Finish

Kanebridge Part #	Blue Devil [®] Number	Size	Ctn Qty	Wght Lbs/C
0402SSC	33018	4-40X1/8	100	0.04
0403SSC	33020	4-40X3/16	100	0.05
0404SSC	33022	4-40X1/4	100	0.06
0405SSC	33024	4-40X5/16	100	0.07
0406SSC	33026	4-40X3/8	100	0.08
0408SSC	33030	4-40X1/2	100	0.11
0410SSC	33032	4-40X5/8	100	0.13
0502SSC	33034	5-40X1/8	100	0.04
0503SSC	33036	5-40X3/16	100	0.06
0504SSC	33038	5-40X1/4	100	0.07
0506SSC	33042	5-40X3/8	100	0.11
0508SSC	33044	5-40X1/2	100	0.13
0510SSC	33046	5-40X5/8	100	0.16
0602SSC	33050	6-32X1/8	100	0.05
0603SSC	33052	6-32X3/16	100	0.06
0604SSC	33054	6-32X1/4	100	0.08
0605SSC	33056	6-32X5/16	100	0.10
0606SSC	33058	6-32X3/8	100	0.12
0608SSC	33062	6-32X1/2	100	0.16
0610SSC	33064	6-32X5/8	100	0.19
0612SSC	33066	6-32X3/4	100	0.22
0616SSC	33070	6-32X1	100	0.31
0802SSC	33072	8-32X1/8	100	0.05
0803SSC	33074	8-32X3/16	100	0.07
0804SSC	33076	8-32X1/4	100	0.10

More sizes on next column

Alloy Steel with
Black Oxide Finish



Free Manufacturer's
Certifications Available

BLUE DEVIL[®] BRAND SOCKET SET SCREWS CUP POINT / U.N.C. COARSE THREAD

All Items are Made in the U.S.A.
Manufactured to ASME B18.3 specifications
Class 3A Threads / Black Oxide Finish

Kanebridge Part #	Blue Devil [®] Number	Size	Ctn Qty	Wght Lbs/C
0805SSC	33078	8-32X5/16	100	0.14
0806SSC	33080	8-32X3/8	100	0.20
0808SSC	33084	8-32X1/2	100	0.21
0810SSC	33086	8-32X5/8	100	0.28
0812SSC	33088	8-32X3/4	100	0.34
0814SSC	33090	8-32X7/8	100	0.39
0816SSC	33092	8-32X1	100	0.44
1003SSC	33094	10-24X3/16	100	0.09
1004SSC	33096	10-24X1/4	100	0.13
1005SSC	33098	10-24X5/16	100	0.18
1006SSC	33100	10-24X3/8	100	0.19
1008SSC	33104	10-24X1/2	100	0.26
1010SSC	33106	10-24X5/8	100	0.33
1012SSC	33108	10-24X3/4	100	0.45
1016SSC	33112	10-24X1	100	0.58
1020SSC	33114	10-24X1 1/4	100	0.74
1403SSC	33116	1/4-20X3/16	100	0.13
1404SSC	33118	1/4-20X1/4	100	0.17
1405SSC	33120	1/4-20X5/16	100	0.23
1406SSC	33122	1/4-20X3/8	100	0.27
1408SSC	33126	1/4-20X1/2	100	0.44
1410SSC	33128	1/4-20X5/8	100	0.58
1412SSC	33130	1/4-20X3/4	100	0.71
1414SSC	33132	1/4-20X7/8	100	0.87
1416SSC	33134	1/4-20X1	100	0.97
1420SSC	33136	1/4-20X1 1/4	100	1.21
1424SSC	33138	1/4-20X1 1/2	100	1.50
1428SSC	33140	1/4-20X1 3/4	100	1.74
1432SSC	33142	1/4-20X2	100	2.00
3104SSC	33144	5/16-18X1/4	100	0.27
3105SSC	33146	5/16-18X5/16	100	0.37
3106SSC	33148	5/16-18X3/8	100	0.49
3107SSC	33150	5/16-18X7/16	100	0.58
3108SSC	33152	5/16-18X1/2	100	0.66
3110SSC	33154	5/16-18X5/8	100	1.00
3112SSC	33156	5/16-18X3/4	100	1.08
3114SSC	33158	5/16-18X7/8	100	1.30
3116SSC	33160	5/16-18X1	100	1.50
3120SSC	33162	5/16-18X1 1/4	100	2.00
3124SSC	33164	5/16-18X1 1/2	100	2.40
3128SSC	33166	5/16-18X1 3/4	100	2.70
3132SSC	33168	5/16-18X2	100	2.80
3704SSC	33170	3/8-16X1/4	100	0.40
3705SSC	33172	3/8-16X5/16	100	0.50
3706SSC	33174	3/8-16X3/8	100	0.62
3707SSC	33176	3/8-16X7/16	100	0.77
3708SSC	33178	3/8-16X1/2	100	1.00
3710SSC	33180	3/8-16X5/8	100	1.30
3712SSC	33182	3/8-16X3/4	100	1.50
3714SSC	33184	3/8-16X7/8	100	1.90
3716SSC	33186	3/8-16X1	100	2.20
3720SSC	33188	3/8-16X1 1/4	100	2.80
3724SSC	33190	3/8-16X1 1/2	100	3.50
3728SSC	33192	3/8-16X1 3/4	100	4.10
3732SSC	33194	3/8-16X2	100	4.70
3740SSC	33196	3/8-16X2 1/2	100	6.10
4306SSC	33198	7/16-14X3/8	100	0.93
4308SSC	33202	7/16-14X1/2	100	1.20
4310SSC	33204	7/16-14X5/8	100	1.60
4312SSC	33206	7/16-14X3/4	100	2.04
4314SSC	33208	7/16-14X7/8	100	2.50
4316SSC	33210	7/16-14X1	100	2.94
4320SSC	33212	7/16-14X1 1/4	50	3.80
4332SSC	33216	7/16-14X2	50	6.60

More sizes on page 353

Alloy Steel with
Black Oxide Finish



Free Manufacturer's
Certifications Available

BLUE DEVIL® BRAND SOCKET SET SCREWS
CUP POINT / U.N.C. COARSE THREAD

All Items are Made in the U.S.A.
Manufactured to ASME B18.3 specifications
Class 3A Threads / Black Oxide Finish

Kanebridge Part #	Blue Devil® Number	Size	Ctn Qty	Wght Lbs/C
5006SSC	33218	1/2-13X3/8	100	1.20
5008SSC	33220	1/2-13X1/2	100	1.50
5010SSC	33222	1/2-13X5/8	100	2.07
5012SSC	33224	1/2-13X3/4	100	2.60
5014SSC	33226	1/2-13X7/8	100	3.20
5016SSC	33228	1/2-13X1	100	3.70
5020SSC	33230	1/2-13X1 1/4	50	5.00
5024SSC	33232	1/2-13X1 1/2	50	6.00
5028SSC	33234	1/2-13X1 3/4	50	7.20
5032SSC	33236	1/2-13X2	50	8.46
5040SSC	33238	1/2-13X2 1/2	50	10.60
5048SSC	33240	1/2-13X3	50	13.00
6208SSC	33242	5/8-11X1/2	50	2.44
6210SSC	33244	5/8-11X5/8	50	3.20
6212SSC	33246	5/8-11X3/4	50	4.00
6216SSC	33248	5/8-11X1	50	5.20
6220SSC	33250	5/8-11X1 1/4	50	7.60
6224SSC	33252	5/8-11X1 1/2	50	9.20
6228SSC	33254	5/8-11X1 3/4	50	11.20
6232SSC	33256	5/8-11X2	50	13.00
6240SSC	33258	5/8-11X2 1/2	50	16.40
6248SSC	33260	5/8-11X3	50	20.00
7510SSC	33262	3/4-10X5/8	50	4.72
7512SSC	33264	3/4-10X3/4	50	5.40
7516SSC	33266	3/4-10X1	50	7.96
7520SSC	33268	3/4-10X1 1/4	50	11.00
7524SSC	33270	3/4-10X1 1/2	50	13.60
7528SSC	33272	3/4-10X1 3/4	50	15.84
7532SSC	33274	3/4-10X2	25	18.44
7540SSC	33276	3/4-10X2 1/2	25	23.60
7548SSC	33278	3/4-10X3	25	28.92
10016SSC	33292	1-8X1	10	11.68
10024SSC	33294	1-8X1 1/2	10	21.00
10032SSC	33296	1-8X2	10	30.00
10048SSC	33300	1-8X3	10	49.20

Alloy Steel with
Black Oxide Finish



Free Manufacturer's
Certifications Available

BLUE DEVIL® BRAND SOCKET SET SCREWS
OVAL POINT / U.N.C. COARSE THREAD

All Items are Made in the U.S.A.
Manufactured to ASME B18.3 specifications
Class 3A Threads / Black Oxide Finish

Kanebridge Part #	Blue Devil® Number	Size	Ctn Qty	Wght Lbs/C
1408SSO	37022	1/4-20X1/2	100	0.50
3710SSO	37048	3/8-16X5/8	100	1.27

Alloy Steel with
Black Oxide Finish



Free Manufacturer's
Certifications Available

BLUE DEVIL® BRAND SOCKET SET SCREWS
CUP POINT / U.N.F. FINE THREAD

All Items are Made in the U.S.A.
Manufactured to ASME B18.3 specifications
Class 3A Threads / Black Oxide Finish

Kanebridge Part #	Blue Devil® Number	Size	Ctn Qty	Wght Lbs/C
04F02SSC	32019	4-48X1/8	100	0.04
04F04SSC	32023	4-48X1/4	100	0.07
06F02SSC	32031	6-40X1/8	100	0.04
06F03SSC	32033	6-40X3/16	100	0.06
06F04SSC	32035	6-40X1/4	100	0.09
06F06SSC	32039	6-40X3/8	100	0.13
08F03SSC	32043	8-36X3/16	100	0.08
08F04SSC	32045	8-36X1/4	100	0.10
08F08SSC	32051	8-36X1/2	100	0.22
1103SSC	32053	10-32X3/16	100	0.10
1104SSC	32055	10-32X1/4	100	0.13
1105SSC	32057	10-32X5/16	100	0.17
1106SSC	32059	10-32X3/8	100	0.21
1108SSC	32063	10-32X1/2	100	0.27
1110SSC	32065	10-32X5/8	100	0.37
1112SSC	32067	10-32X3/4	100	0.44
1116SSC	32069	10-32X1	100	0.61
1120SSC	32071	10-32X1 1/4	100	0.80
1503SSC	32073	1/4-28X3/16	100	0.16
1504SSC	32075	1/4-28X1/4	100	0.20
1505SSC	32077	1/4-28X5/16	100	0.26
1506SSC	32079	1/4-28X3/8	100	0.33
1508SSC	32083	1/4-28X1/2	100	0.50
1510SSC	32085	1/4-28X5/8	100	0.64
1512SSC	32087	1/4-28X3/4	100	0.75
1516SSC	32089	1/4-28X1	100	1.10
1520SSC	32091	1/4-28X1 1/4	100	1.30
3204SSC	32093	5/16-24X1/4	100	0.30
3205SSC	32095	5/16-24X5/16	100	0.39
3206SSC	32097	5/16-24X3/8	100	0.55
3208SSC	32099	5/16-24X1/2	100	0.77
3210SSC	32101	5/16-24X5/8	100	0.95
3212SSC	32103	5/16-24X3/4	100	1.20
3216SSC	32105	5/16-24X1	100	1.62
3804SSC	32107	3/8-24X1/4	100	0.53
3806SSC	32109	3/8-24X3/8	100	0.69
3808SSC	32111	3/8-24X1/2	100	1.06
3810SSC	32113	3/8-24X5/8	100	1.29
3812SSC	32115	3/8-24X3/4	100	1.68
3816SSC	32117	3/8-24X1	100	2.50
3820SSC	32119	3/8-24X1 1/4	100	2.99
3824SSC	32121	3/8-24X1 1/2	100	3.69
5108SSC	32129	1/2-20X1/2	100	1.66
5112SSC	32131	1/2-20X3/4	100	2.90
5116SSC	32133	1/2-20X1	100	4.11
6310SSC	32135	5/8-18X5/8	50	3.38

Alloy Steel with
Black Oxide Finish



Free Manufacturer's
Certifications Available

BLUE DEVIL® BRAND SOCKET SET SCREWS
CONE POINT / U.N.C. COARSE & U.N.F. FINE THREAD

All Items are Made in the U.S.A.
Manufactured to ASME B18.3 specifications
Class 3A Threads / Black Oxide Finish

Kanebridge Part #	Blue Devil® Number	Size	Ctn Qty	Wght Lbs/C
0603SSN	34010	6-32X3/16	100	0.06
0604SSN	34012	6-32X1/4	100	0.07
0804SSN	34016	8-32X1/4	100	0.09
0806SSN	34020	8-32X3/8	100	0.13
1004SSN	34024	10-24X1/4	100	0.10
1006SSN	34026	10-24X3/8	100	0.18
1406SSN	34034	1/4-20X3/8	100	0.23
3106SSN	34046	5/16-18X3/8	100	0.36
3108SSN	34048	5/16-18X1/2	100	0.55
3708SSN	34056	3/8-16X1/2	100	0.74
1104SSN	34073	10-32X1/4	100	0.11
1504SSN	34075	1/4-28X1/4	100	0.30

Alloy Steel with
Black Oxide Finish



Free Manufacturer's
Certifications Available

BLUE DEVIL® BRAND SOCKET SET SCREWS
HALF DOG POINT / U.N.C. COARSE & U.N.F. FINE THREAD

All Items are Made in the U.S.A.
Manufactured to ASME B18.3 specifications
Class 3A Threads / Black Oxide Finish

Kanebridge Part #	Blue Devil® Number	Size	Ctn Qty	Wght Lbs/C
1103SSD	35081	10-32X3/16	100	0.10
1506SSD	35087	1/4-28X3/8	100	0.32
3206SSD	35089	5/16-24X3/8	100	0.49

Alloy Steel with
Black Oxide Finish



Free Manufacturer's
Certifications Available

BLUE DEVIL® BRAND SOCKET SET SCREWS
FLAT POINT / U.N.C. COARSE & U.N.F. FINE THREAD

All Items are Made in the U.S.A.
Manufactured to ASME B18.3 specifications
Class 3A Threads / Black Oxide Finish

Kanebridge Part #	Blue Devil® Number	Size	Ctn Qty	Wght Lbs/C
0402SSF	36000	4-40X1/8	100	0.04
0403SSF	36002	4-40X3/16	100	0.05
0404SSF	36004	4-40X1/4	100	0.06
0602SSF	36012	6-32X1/8	100	0.05
0603SSF	36014	6-32X3/16	100	0.06
0606SSF	36020	6-32X3/8	100	0.11
0803SSF	36024	8-32X3/16	100	0.08
0806SSF	36030	8-32X3/8	100	0.17
0808SSF	36032	8-32X1/2	100	0.22
1003SSF	36036	10-24X3/16	100	0.09
1004SSF	36038	10-24X1/4	100	0.13
1005SSF	36040	10-24X5/16	100	0.16
1006SSF	36042	10-24X3/8	100	0.20
1103SSF	36101	10-32X3/16	100	0.09
1403SSF	36048	1/4-20X3/16	100	0.13
1405SSF	36052	1/4-20X5/16	100	0.26
1408SSF	36056	1/4-20X1/2	100	0.47
1410SSF	36058	1/4-20X5/8	100	0.60
1412SSF	36060	1/4-20X3/4	100	0.72
1506SSF	36107	1/4-28X3/8	100	0.32
3105SSF	36066	5/16-18X5/16	100	0.40
3106SSF	36068	5/16-18X3/8	100	0.50
3108SSF	36070	5/16-18X1/2	100	0.70
3116SSF	36076	5/16-18X1	100	1.50
3206SSF	36111	5/16-24X3/8	100	0.50
3704SSF	36078	3/8-16X1/4	100	0.49
3706SSF	36080	3/8-16X3/8	100	0.62
3716SSF	36088	3/8-16X1	100	2.30
3806SSF	36113	3/8-24X3/8	100	0.64
3808SSF	36115	3/8-24X1/2	100	1.00
5008SSF	36092	1/2-13X1/2	100	1.50

Alloy Steel with
Black Oxide Finish



Free Manufacturer's
Certifications Available

BLUE DEVIL® BRAND SOCKET SET SCREWS
HALF DOG POINT / U.N.C. COARSE & U.N.F. FINE THREAD

All Items are Made in the U.S.A.
Manufactured to ASME B18.3 specifications
Class 3A Threads / Black Oxide Finish

Kanebridge Part #	Blue Devil® Number	Size	Ctn Qty	Wght Lbs/C
0804SSD	35002	8-32X1/4	100	0.10
0808SSD	35008	8-32X1/2	100	0.21
1004SSD	35012	10-24X1/4	100	0.13
1404SSD	35020	1/4-20X1/4	100	0.18
1405SSD	35022	1/4-20X5/16	100	0.24
1408SSD	35026	1/4-20X1/2	100	0.39
1410SSD	35028	1/4-20X5/8	100	0.57
3105SSD	35034	5/16-18X5/16	100	0.36
3106SSD	35036	5/16-18X3/8	100	0.43
3108SSD	35038	5/16-18X1/2	100	0.66
3112SSD	35042	5/16-18X3/4	100	1.00
3706SSD	35046	3/8-16X3/8	100	0.63
3708SSD	35048	3/8-16X1/2	100	0.87
3710SSD	35050	3/8-16X5/8	100	1.20
3716SSD	35054	3/8-16X1	100	2.20
5008SSD	35058	1/2-13X1/2	100	1.60
5012SSD	35062	1/2-13X3/4	100	2.57

Heat Treated Alloy Steel



Free Manufacturer's
Certifications Available

BLUE DEVIL® BRAND DOWEL PINS
BRIGHT FINISH

All Items are Made in the U.S.A.
Manufactured to ASME B18.8.2 specifications
Standard Size / .0002 Over Diameter

Kanebridge Part #	Blue Devil® Number	Size	Ctn Qty	Wght Lbs/C
0012506PDB	11001	1/8X3/8	100	0.15
0012508PDB	11004	1/8X1/2	100	0.18
0012510PDB	11007	1/8X5/8	100	0.23
0012512PDB	11010	1/8X3/4	100	0.28
0012514PDB	11013	1/8X7/8	100	0.32
0012516PDB	11016	1/8X1	100	0.36
0012520PDB	11019	1/8X1 1/4	100	0.45
0012524PDB	11022	1/8X1 1/2	100	0.56
0012528PDB	11025	1/8X1 3/4	100	0.64
0012532PDB	11028	1/8X2	100	0.70
1008PDB	11031	3/16X1/2	100	0.40
1010PDB	11034	3/16X5/8	100	0.50
1012PDB	11037	3/16X3/4	100	0.62
1014PDB	11040	3/16X7/8	100	0.71
1016PDB	11043	3/16X1	100	0.81
1020PDB	11046	3/16X1 1/4	100	1.00
1024PDB	11049	3/16X1 1/2	100	1.10
1028PDB	11052	3/16X1 3/4	100	1.30
1032PDB	11055	3/16X2	100	1.59
1408PDB	11058	1/4X1/2	100	0.72
1410PDB	11061	1/4X5/8	100	0.90
1412PDB	11064	1/4X3/4	100	1.05
1414PDB	11067	1/4X7/8	100	1.25
1416PDB	11070	1/4X1	100	1.48
1420PDB	11073	1/4X1 1/4	100	1.77
1424PDB	11076	1/4X1 1/2	100	2.11
1428PDB	11079	1/4X1 3/4	100	2.45
1432PDB	11082	1/4X2	100	2.66
1436PDB	11085	1/4X2 1/4	100	3.21
1440PDB	11088	1/4X2 1/2	100	3.54
3108PDB	11091	5/16X1/2	100	1.10
3110PDB	11094	5/16X5/8	100	1.36
3112PDB	11097	5/16X3/4	100	1.61
3114PDB	11100	5/16X7/8	100	1.90
3116PDB	11103	5/16X1	100	2.17
3120PDB	11106	5/16X1 1/4	100	2.72
3124PDB	11109	5/16X1 1/2	100	3.38
3128PDB	11112	5/16X1 3/4	100	3.83
3132PDB	11115	5/16X2	100	4.40
3136PDB	11118	5/16X2 1/4	100	4.92
3140PDB	11121	5/16X2 1/2	100	5.50
3148PDB	11124	5/16X3	100	6.73
3708PDB	11127	3/8X1/2	40	1.60
3710PDB	11130	3/8X5/8	40	2.00
3712PDB	11133	3/8X3/4	40	2.40
3714PDB	11136	3/8X7/8	40	2.80
3716PDB	11139	3/8X1	40	3.18
3720PDB	11142	3/8X1 1/4	40	3.93
3724PDB	11145	3/8X1 1/2	40	4.75
3728PDB	11148	3/8X1 3/4	40	5.53
3732PDB	11151	3/8X2	40	6.33
3736PDB	11154	3/8X2 1/4	40	7.10
3740PDB	11157	3/8X2 1/2	40	8.10
3748PDB	11160	3/8X3	40	9.30

More sizes on next column

Heat Treated Alloy Steel



Free Manufacturer's
Certifications Available

BLUE DEVIL® BRAND DOWEL PINS
BRIGHT FINISH

All Items are Made in the U.S.A.
Manufactured to ASME B18.8.2 specifications
Standard Size / .0002 Over Diameter

Kanebridge Part #	Blue Devil® Number	Size	Ctn Qty	Wght Lbs/C
4316PDB	11163	7/16X1	40	4.38
4320PDB	11166	7/16X1 1/4	40	5.35
4324PDB	11169	7/16X1 1/2	40	6.43
4328PDB	11172	7/16X1 3/4	40	7.50
4332PDB	11175	7/16X2	40	8.60
4340PDB	11178	7/16X2 1/2	40	10.85
4348PDB	11181	7/16X3	40	13.00
5012PDB	11184	1/2X3/4	20	4.25
5016PDB	11187	1/2X1	20	5.65
5020PDB	11190	1/2X1 1/4	20	7.00
5024PDB	11193	1/2X1 1/2	20	8.20
5028PDB	11196	1/2X1 3/4	20	9.75
5032PDB	11199	1/2X2	20	11.15
5036PDB	11202	1/2X2 1/4	20	12.60
5040PDB	11205	1/2X2 1/2	20	13.95
5048PDB	11208	1/2X3	20	16.75
5056PDB	11211	1/2X3 1/2	20	19.70
5064PDB	11214	1/2X4	20	22.35
6216PDB	11217	5/8X1	10	8.80
6220PDB	11220	5/8X1 1/4	10	11.00
6224PDB	11223	5/8X1 1/2	10	12.80
6228PDB	11226	5/8X1 3/4	10	15.40
6232PDB	11229	5/8X2	10	18.00
6236PDB	11232	5/8X2 1/4	10	19.00
6240PDB	11235	5/8X2 1/2	10	21.80
6248PDB	11238	5/8X3	10	26.30
6256PDB	11241	5/8X3 1/2	10	30.00
6264PDB	11244	5/8X4	10	36.00
6272PDB	11247	5/8X4 1/2	10	39.50
6280PDB	11250	5/8X5	10	43.00
7532PDB	11253	3/4X2	10	25.10
7540PDB	11256	3/4X2 1/2	10	31.30
7548PDB	11259	3/4X3	10	37.85
7556PDB	11262	3/4X3 1/2	10	44.00
7564PDB	11265	3/4X4	10	50.00
7572PDB	11268	3/4X4 1/2	10	56.40
7580PDB	11271	3/4X5	10	62.90
7596PDB	11274	3/4X6	10	76.50
8732PDB	11277	7/8X2	10	34.30
8748PDB	11283	7/8X3	10	51.30
8764PDB	11289	7/8X4	10	69.15
10032PDB	11301	1X2	10	45.00
10040PDB	11304	1X2 1/2	10	56.50
10048PDB	11307	1X3	10	68.00
10056PDB	11310	1X3 1/2	10	79.50
10064PDB	11313	1X4	10	90.00
10080PDB	11319	1X5	10	112.00
10096PDB	11322	1X6	10	134.30

Alloy Steel with
Black Oxide Finish



Free Manufacturer's
Certifications Available

Alloy Steel with
Black Oxide Finish



Free Manufacturer's
Certifications Available

BLUE DEVIL® BRAND DOWEL PINS EBONY FINISH

All Items are Made in the U.S.A.
Manufactured to ASME B18.8.2 specifications
Standard Size / .0002 Over Diameter

Kanebridge Part #	Blue Devil® Number	Size	Ctn Qty	Wght Lbs/C
0012506PDE	31001	1/8X3/8	100	0.05
0012508PDE	31004	1/8X1/2	100	0.10
0012510PDE	31007	1/8X5/8	100	0.23
0012512PDE	31010	1/8X3/4	100	0.28
0012514PDE	31013	1/8X7/8	100	0.30
0012516PDE	31016	1/8X1	100	0.34
0012520PDE	31019	1/8X1 1/4	100	0.45
0012524PDE	31022	1/8X1 1/2	100	0.52
0012528PDE	31025	1/8X1 3/4	100	0.60
0012532PDE	31028	1/8X2	100	0.67
1008PDE	31031	3/16X1/2	100	0.40
1010PDE	31034	3/16X5/8	100	0.50
1012PDE	31037	3/16X3/4	100	0.60
1014PDE	31040	3/16X7/8	100	0.60
1016PDE	31043	3/16X1	100	0.81
1020PDE	31046	3/16X1 1/4	100	0.90
1024PDE	31049	3/16X1 1/2	100	1.10
1028PDE	31052	3/16X1 3/4	100	1.30
1032PDE	31055	3/16X2	100	1.50
1408PDE	31058	1/4X1/2	100	0.72
1410PDE	31061	1/4X5/8	100	0.80
1412PDE	31064	1/4X3/4	100	1.04
1414PDE	31067	1/4X7/8	100	1.10
1416PDE	31070	1/4X1	100	1.38
1420PDE	31073	1/4X1 1/4	100	1.70
1424PDE	31076	1/4X1 1/2	100	2.11
1428PDE	31079	1/4X1 3/4	100	2.40
1432PDE	31082	1/4X2	100	2.70
1436PDE	31085	1/4X2 1/4	100	3.10
1440PDE	31088	1/4X2 1/2	100	3.40
3108PDE	31091	5/16X1/2	100	1.00
3110PDE	31094	5/16X5/8	100	1.30
3112PDE	31097	5/16X3/4	100	1.60
3114PDE	31100	5/16X7/8	100	1.80
3116PDE	31103	5/16X1	100	2.10
3120PDE	31106	5/16X1 1/4	100	2.60
3124PDE	31109	5/16X1 1/2	100	3.20
3128PDE	31112	5/16X1 3/4	100	3.70
3132PDE	31115	5/16X2	100	4.30
3136PDE	31118	5/16X2 1/4	100	4.80
3140PDE	31121	5/16X2 1/2	100	5.30
3148PDE	31124	5/16X3	100	6.40
3708PDE	31127	3/8X1/2	40	1.50
3710PDE	31130	3/8X5/8	40	1.80
3712PDE	31133	3/8X3/4	40	2.20
3714PDE	31136	3/8X7/8	40	2.60
3716PDE	31139	3/8X1	40	3.25
3720PDE	31142	3/8X1 1/4	40	3.93
3724PDE	31145	3/8X1 1/2	40	4.73
3728PDE	31148	3/8X1 3/4	40	5.40
3732PDE	31151	3/8X2	40	6.33
3736PDE	31154	3/8X2 1/4	40	6.90
3740PDE	31157	3/8X2 1/2	40	7.70
3748PDE	31160	3/8X3	40	9.43

More sizes on next column

BLUE DEVIL® BRAND DOWEL PINS EBONY FINISH

All Items are Made in the U.S.A.
Manufactured to ASME B18.8.2 specifications
Standard Size / .0002 Over Diameter

Kanebridge Part #	Blue Devil® Number	Size	Ctn Qty	Wght Lbs/C
4316PDE	31163	7/16X1	40	4.28
4320PDE	31166	7/16X1 1/4	40	5.20
4324PDE	31169	7/16X1 1/2	40	6.43
4328PDE	31172	7/16X1 3/4	40	7.30
4332PDE	31175	7/16X2	40	8.73
4340PDE	31178	7/16X2 1/2	40	10.90
4348PDE	31181	7/16X3	40	12.60
5012PDE	31184	1/2X3/4	20	4.00
5016PDE	31187	1/2X1	20	5.40
5020PDE	31190	1/2X1 1/4	20	6.80
5024PDE	31193	1/2X1 1/2	20	8.40
5028PDE	31196	1/2X1 3/4	20	9.85
5032PDE	31199	1/2X2	20	11.15
5036PDE	31202	1/2X2 1/4	20	12.30
5040PDE	31205	1/2X2 1/2	20	13.70
5048PDE	31208	1/2X3	20	16.75
5056PDE	31211	1/2X3 1/2	20	19.20
5064PDE	31214	1/2X4	20	22.50
6216PDE	31217	5/8X1	10	8.40
6220PDE	31220	5/8X1 1/4	10	10.60
6224PDE	31223	5/8X1 1/2	10	13.20
6228PDE	31226	5/8X1 3/4	10	14.90
6232PDE	31229	5/8X2	10	17.50
6236PDE	31232	5/8X2 1/4	10	19.20
6240PDE	31235	5/8X2 1/2	10	21.40
6248PDE	31238	5/8X3	10	25.70
6256PDE	31241	5/8X3 1/2	10	30.00
6264PDE	31244	5/8X4	10	34.95
6272PDE	31247	5/8X4 1/2	10	38.60
6280PDE	31250	5/8X5	10	43.00
7532PDE	31253	3/4X2	10	24.60
7540PDE	31256	3/4X2 1/2	10	30.80
7548PDE	31259	3/4X3	10	37.00
7556PDE	31262	3/4X3 1/2	10	43.20
7564PDE	31265	3/4X4	10	49.60
7572PDE	31268	3/4X4 1/2	10	56.50
7580PDE	31271	3/4X5	10	62.10
7596PDE	31274	3/4X6	10	77.00
8732PDE	31277	7/8X2	10	35.00
8740PDE	31280	7/8X2 1/2	10	43.00
8748PDE	31283	7/8X3	10	50.40
8764PDE	31289	7/8X4	10	67.50
10032PDE	31301	1X2	10	45.00
10040PDE	31304	1X2 1/2	10	56.00
10048PDE	31307	1X3	10	65.80
10056PDE	31310	1X3 1/2	10	77.10
10064PDE	31313	1X4	10	89.90
10080PDE	31319	1X5	10	113.00

Alloy Steel with
Black Oxide Finish



Free Manufacturer's
Certifications Available

BLUE DEVIL® BRAND DRY SEAL SOCKET
PIPE PLUG—STEEL – 3/4” TAPER

All Items are Made in the U.S.A.
Manufactured to ANSI B1.20.3 specifications

Kanebridge Part #	Blue Devil® Number	Size	Ctn Qty	Wght Lbs/C
00062PPS	14004	1/16	100	0.44
00125PPS	14007	1/8	100	0.82
00250PPS	14010	1/4	100	1.88
00375PPS	14013	3/8	100	3.70
00500PPS	14016	1/2	50	6.00
00750PPS	14019	3/4	50	10.40
01000PPS	14022	1	25	20.40

Alloy Steel with
Black Oxide Finish



Free Manufacturer's
Certifications Available

BLUE DEVIL® BRAND FLUSH SEATING SOCKET
PIPE PLUG—STEEL – 7/8” TAPER

All Items are Made in the U.S.A.
Manufactured to ANSI B1.20.3 specifications

Kanebridge Part #	Blue Devil® Number	Size	Ctn Qty	Wght Lbs/C
00062PPSF	15004	1/16	100	0.30
00125PPSF	15007	1/8	100	0.59
00250PPSF	15010	1/4	100	1.63
00375PPSF	15013	3/8	100	2.60
00500PPSF	15016	1/2	50	5.20
00750PPSF	15019	3/4	50	12.20
01000PPSF	15022	1	25	16.44
01250PPSF	15025	1 1/4	25	28.00

Alloy Steel with
Black Oxide Finish



BLUE DEVIL® BRAND HEX WRENCHES
SHORT ARM

All Items are Made in the U.S.A.
Manufactured to ASME B18.3 specifications

Kanebridge Part #	Blue Devil® Number	Size	Ctn Qty	Wght Lbs/C
00028KHS	22001	.028	100	0.05
00035KHS	22004	.035	100	0.07
00050KHS	22007	.050	100	0.18
00062KHS	22010	1/16	100	0.26
00078KHS	22013	5/64	100	0.40
00093KHS	22016	3/32	100	0.62
00109KHS	22019	7/64	100	0.88
00125KHS	22022	1/8	100	1.18
00141KHS	22025	9/64	100	1.60
00156KHS	22028	5/32	100	2.06
00188KHS	22031	3/16	100	3.50
00219KHS	22034	7/32	100	4.95
00250KHS	22037	1/4	100	7.20
00312KHS	22040	5/16	100	12.50
00375KHS	22043	3/8	50	19.60
00438KHS	22045	7/16	10	30.00
00500KHS	22048	1/2	10	43.20
00562KHS	22051	9/16	10	60.00
00625KHS	22054	5/8	10	83.00
00750KHS	22057	3/4	5	134.00
00875KHS	22060	7/8	5	216.00
01000KHS	22063	1	5	300.00

Commercial Brass



Free Manufacturer's
Certifications Available

BLUE DEVIL® BRAND DRY SEAL SOCKET
PIPE PLUG—BRASS – 3/4” TAPER

All Items are Made in the U.S.A.
Manufactured to ANSI B1.20.3 specifications

Kanebridge Part #	Blue Devil® Number	Size	Ctn Qty	Wght Lbs/C
00062PPSB	16004	1/16	100	0.45
00125PPSB	16007	1/8	100	0.83
00250PPSB	16010	1/4	100	1.97
00375PPSB	16013	3/8	100	3.90
00500PPSB	16016	1/2	50	7.00

Commercial Brass



Free Manufacturer's
Certifications Available

BLUE DEVIL® BRAND FLUSH SEATING SOCKET
PIPE PLUG—BRASS – 7/8” TAPER

All Items are Made in the U.S.A.
Manufactured to ANSI B1.20.3 specifications

Kanebridge Part #	Blue Devil® Number	Size	Ctn Qty	Wght Lbs/C
00062PPSFB	16024	1/16	100	0.35
00125PPSFB	16027	1/8	100	0.60
00250PPSFB	16030	1/4	100	1.73
00375PPSFB	16033	3/8	100	2.72
00500PPSFB	16036	1/2	50	2.90

Alloy Steel with
Black Oxide Finish



BLUE DEVIL® BRAND HEX WRENCHES
LONG ARM

All Items are Made in the U.S.A.
Manufactured to ASME B18.3 specifications

Kanebridge Part #	Blue Devil® Number	Size	Ctn Qty	Wght Lbs/C
00062KHL	23001	1/16	100	0.41
00078KHL	23004	5/64	100	0.60
00093KHL	23007	3/32	100	0.92
00109KHL	23010	7/64	100	1.26
00125KHL	23013	1/8	100	1.77
00141KHL	23016	9/64	100	2.35
00156KHL	23019	5/32	100	3.00
00188KHL	23022	3/16	100	4.80
00219KHL	23025	7/32	100	7.00
00250KHL	23028	1/4	100	10.00
00312KHL	23031	5/16	100	17.80
00375KHL	23034	3/8	50	28.00
00438KHL	23037	7/16	10	45.00
00500KHL	23040	1/2	10	62.20
00562KHL	23043	9/16	10	86.70
00625KHL	23046	5/8	10	114.40
00750KHL	23049	3/4	2	195.00
00875KHL	23052	7/8	2	297.00
01000KHL	23055	1	2	426.25

Heat Treated Alloy Steel



BLUE DEVIL® TAMPER PROOF HEX WRENCHES

Hardness: Rockwell C48 min
Manufactured to ASME B18.3 specifications

Kanebridge Part #	Blue Devil® Number	Size	Ctn Qty	Wght Lbs/C
00125KHTP	22100	1/8	25	1.11
00188KHTP	22104	3/16	100	3.23

Heat Treated Alloy Steel



BLUE DEVIL® SHORT ARM HEX WRENCH SET

Hardness: Rockwell C48 min (thru 3/8"); C45 min (over 3/8")
Manufactured to ASME B18.3 specifications

Kanebridge Part #	Blue Devil® Number	Size	Ctn Qty	Wght Lbs/C
10BD	21001	1/16-1/4	6	.27
12BD	21005	1/16-3/8	6	.64
15BD	21010	1/16-5/8	6	2.5
606BD	84606	.050-3/8	6	.58

Alloy Steel with Black Oxide Finish



BLUE DEVIL® BRAND LONG ARM HEX WRENCH SET

All Items are Made in the U.S.A.
Manufactured to ASME B18.3 specifications

Kanebridge Part #	Blue Devil® Number	Size	Ctn Qty	Wght Lbs/C
10LBD	21004	1/16-1/4	6	.40
12LBD	21007	1/16-3/8	6	.87
663LBD	84663	5/64-3/4	1	5.50



BLUE DEVIL® SOCKET SCREW GUIDE

Slide Chart
Lists dimensions for most common socket products
Overall size is 4.75" X 10"

Kanebridge Part #	Blue Devil® Number	Size	Ctn Qty	Wght Lbs/C
61195	61195	INCH SIZES	10	.10

Zinc and Clear Finish Plate



Free Manufacturer's Certifications Available

BLUE DEVIL® BRAND SOCKET HEAD CAP SCREWS / CLASS 3A THREADS

All Items are Made in the U.S.A.
Manufactured to ASME B18.3 specifications
Parts are electro-zinc plated, baked & stress tested after plating.

Kanebridge Part #	Blue Devil® Number	Size	Ctn Qty	Wght Lbs/C
0403CS		4-40X3/16	100	0.10
0404CS	44016Z	4-40X1/4	100	0.12
0405CS		4-40X5/16	100	0.13
0406CS	44018Z	4-40X3/8	100	0.13
0408CS	44020Z	4-40X1/2	100	0.15
0410CS	44022Z	4-40X5/8	100	0.18
0412CS	44024Z	4-40X3/4	100	0.23
0416CS		4-40X1	100	0.30
0420CS		4-40X1 1/4	100	0.36
0510CS	44032Z	5-40X5/8	100	0.25
0512CS	44034Z	5-40X3/4	100	0.28
0604CS	44036Z	6-32X1/4	100	0.23
0606CS	44038Z	6-32X3/8	100	0.24
0608CS	44040Z	6-32X1/2	100	0.26
0610CS	44042Z	6-32X5/8	100	0.30
0612CS	44044Z	6-32X3/4	100	0.35
0614CS	44046Z	6-32X7/8	100	0.38
0616CS		6-32X1	100	0.50
0620CS		6-32X1 1/4	100	0.50
0624CS		6-32X1 1/2	100	0.60
0804CS	44050Z	8-32X1/4	100	0.33
0806CS	44052Z	8-32X3/8	100	0.37
0808CS	44054Z	8-32X1/2	100	0.46
0810CS	44056Z	8-32X5/8	100	0.51
0812CS	44058Z	8-32X3/4	100	0.58
0814CS	44060Z	8-32X7/8	100	0.63
0816CS	44062Z	8-32X1	100	0.68
0820CS		8-32X1 1/4	100	0.90
0824CS		8-32X1 1/2	100	1.10
0828CS		8-32X1 3/4	100	1.10
1004CS		10-24X1/4	100	0.50
1006CS	44068Z	10-24X3/8	100	0.52
1008CS	44070Z	10-24X1/2	100	0.59
1010CS	44072Z	10-24X5/8	100	0.70
1012CS	44074Z	10-24X3/4	100	0.78
1014CS	44076Z	10-24X7/8	100	0.82
1016CS	44078Z	10-24X1	100	0.92
1020CS	44080Z	10-24X1 1/4	100	1.09
1024CS	44082Z	10-24X1 1/2	100	1.26
1028CS	44084Z	10-24X1 3/4	100	1.45
1032CS	44086Z	10-24X2	100	1.59
1104CS		10-32X1/4	100	0.50
1105CS		10-32X5/16	100	0.55
1106CS	45033Z	10-32X3/8	100	0.57
1108CS	45035Z	10-32X1/2	100	0.61
1110CS	45037Z	10-32X5/8	100	0.73
1112CS	45039Z	10-32X3/4	100	0.81
1114CS	45041Z	10-32X7/8	100	0.85
1116CS	45043Z	10-32X1	100	0.93
1120CS	45045Z	10-32X1 1/4	100	1.13
1124CS	45047Z	10-32X1 1/2	100	1.32
1128CS	45049Z	10-32X1 3/4	100	1.52
1132CS	45051Z	10-32X2	100	1.67
1136CS	84101Z	10-32X2 1/4	100	1.94
1140CS	84102Z	10-32X2 1/2	100	2.06
1148CS	84104Z	10-32X3	100	2.45
1404CS		1/4-20X1/4	100	0.90
1406CS	44088Z	1/4-20X3/8	100	0.95
1408CS	44090Z	1/4-20X1/2	100	1.13
1410CS	44092Z	1/4-20X5/8	100	1.25
1412CS	44094Z	1/4-20X3/4	100	1.38
1414CS	44096Z	1/4-20X7/8	100	1.47
1416CS	44098Z	1/4-20X1	100	1.68

More sizes on page 359

Zinc and Clear Finish Plate



Free Manufacturer's Certifications Available

Heat Treated Alloy Steel per ASTM A574M

METRIC



Free Manufacturer's Certifications Available

BLUE DEVIL® BRAND SOCKET HEAD CAP SCREWS / CLASS 3A THREADS

All Items are Made in the U.S.A.
Manufactured to ASME B18.3 specifications
Parts are electro-zinc plated, baked & stress tested after plating.

BLUE DEVIL® SOCKET HEAD CAP SCREWS ISO METRIC THREAD

Manufactured to ISO 4762 dimensions
Tensile Strength: 1,220 N/mm² minimum

Kanebridge Part #	Blue Devil® Number	Size	Ctn Qty	Wght Lbs/C
1420CS	44100Z	1/4-20X1 1/4	100	1.91
1424CS	44102Z	1/4-20X1 1/2	100	2.29
1428CS	44104Z	1/4-20X1 3/4	100	2.51
1432CS	44106Z	1/4-20X2	100	2.96
1436CS	44108Z	1/4-20X2 1/4	100	3.18
1440CS	44110Z	1/4-20X2 1/2	100	3.67
1448CS	44113Z	1/4-20X3	100	4.32
1456CS		1/4-20X3 1/2	50	5.10
1508CS		1/4-28X1/2	100	1.20
1510CS		1/4-28X5/8	100	1.40
1512CS		1/4-28X3/4	100	1.50
1514CS		1/4-28X7/8	100	1.65
1516CS		1/4-28X1	100	1.80
1520CS		1/4-28X1 1/4	100	2.10
1524CS		1/4-28X1 1/2	100	2.50
3106CS	44116Z	5/16-18X3/8	100	1.70
3108CS	44118Z	5/16-18X1/2	100	1.96
3110CS	44120Z	5/16-18X5/8	100	2.10
3112CS	44118Z	5/16-18X3/4	100	2.32
3114CS		5/16-18X7/8	100	2.70
3116CS	44126Z	5/16-18X1	100	2.75
3120CS	44132Z	5/16-18X1 1/4	100	3.24
3124CS	44130Z	5/16-18X1 1/2	100	3.69
3128CS	44132Z	5/16-18X1 3/4	100	4.26
3132CS	44134Z	5/16-18X2	100	4.63
3136CS	44136Z	5/16-18X2 1/4	100	5.44
3140CS	44138Z	5/16-18X2 1/2	100	5.85
3144CS		5/16-18X2 3/4	100	6.40
3148CS	44142Z	5/16-18X3	100	6.84
3156CS	44146Z	5/16-18X3 1/2	50	7.98
3160CS		5/16-18X3 3/4	50	8.58
3708CS	44148Z	3/8-16X1/2	100	3.15
3710CS	44150Z	3/8-16X5/8	100	3.44
3712CS	44152Z	3/8-16X3/4	100	3.75
3714CS		3/8-16X7/8	100	4.30
3716CS	44156Z	3/8-16X1	100	4.51
3720CS	44158Z	3/8-16X1 1/4	100	4.91
3724CS	44160Z	3/8-16X1 1/2	100	5.67
3728CS	44162Z	3/8-16X1 3/4	100	6.34
3732CS	44164Z	3/8-16X2	100	7.08
3736CS	44166Z	3/8-16X2 1/4	100	7.93
3740CS	44168Z	3/8-16X2 1/2	50	8.53
3744CS		3/8-16X2 3/4	100	9.52
3748CS	44172Z	3/8-16X3	50	10.17
3752CS		3/8-16X3 1/4	50	11.30
3756CS	44176Z	3/8-16X3 1/2	50	11.62
4316CS		7/16-14X1	50	6.90
4320CS		7/16-14X1 1/4	50	7.60
4324CS		7/16-14X1 1/2	100	8.80
5012CS		1/2-13X3/4	50	8.40
5016CS		1/2-13X1	50	9.60
5020CS		1/2-13X1 1/4	50	10.60
5024CS		1/2-13X1 1/2	50	12.60
5028CS		1/2-13X1 3/4	50	13.20
5032CS		1/2-13X2	50	14.40
5040CS		1/2-13X2 1/2	25	17.60
5044CS		1/2-13X2 3/4	25	18.40
5048CS		1/2-13X3	25	19.60

Kanebridge Part #	Blue Devil® Number	Size	Ctn Qty	Wght Lbs/C
M3005CSP	44500	M3-0.5X5	100	0.10
M3006CSP	44502	M3-0.5X6	100	0.10
M3008CSP	44504	M3-0.5X8	100	0.20
M3010CSP	44506	M3-0.5X10	100	0.20
M3012CSP	44508	M3-0.5X12	100	0.20
M3016CSP	44510	M3-0.5X16	100	0.20
M3020CSP	44512	M3-0.5X20	100	0.30
M3025CSP	44514	M3-0.5X25	100	0.30
M3030CSP	44516	M3-0.5X30	100	0.40
M3035CSP	44518	M3-0.5X35	100	0.40
M4005CSP	44520	M4-0.7X5	100	0.20
M4006CSP	44522	M4-0.7X6	100	0.30
M4008CSP	44524	M4-0.7X8	100	0.30
M4010CSP	44526	M4-0.7X10	100	0.40
M4012CSP	44528	M4-0.7X12	100	0.40
M4016CSP	44530	M4-0.7X16	100	0.50
M4020CSP	44532	M4-0.7X20	100	0.60
M4025CSP	44534	M4-0.7X25	100	0.70
M4030CSP	44536	M4-0.7X30	100	0.80
M4035CSP	44538	M4-0.7X35	100	0.90
M4040CSP	44540	M4-0.7X40	100	1.00
M4045CSP	44542	M4-0.7X45	100	1.00
M4050CSP	44544	M4-0.7X50	100	1.00
M5008CSP	44548	M5-0.8X8	100	0.50
M5010CSP	44550	M5-0.8X10	100	0.60
M5012CSP	44552	M5-0.8X12	100	0.60
M5016CSP	44554	M5-0.8X16	100	0.70
M5020CSP	44556	M5-0.8X20	100	0.90
M5025CSP	44558	M5-0.8X25	100	0.90
M5030CSP	44560	M5-0.8X30	100	1.00
M5035CSP	44562	M5-0.8X35	100	1.40
M5040CSP	44564	M5-0.8X40	100	1.50
M5045CSP	44566	M5-0.8X45	100	1.70
M5050CSP	44568	M5-0.8X50	100	1.90
M6008CSP	44578	M6-1X8	100	0.90
M6010CSP	44580	M6-1X10	100	1.00
M6012CSP	44582	M6-1X12	100	1.00
M6016CSP	44584	M6-1X16	100	1.00
M6020CSP	44586	M6-1X20	100	1.40
M6025CSP	44588	M6-1X25	100	1.60
M6030CSP	44590	M6-1X30	100	1.90
M6035CSP	44592	M6-1X35	100	2.00
M6040CSP	44594	M6-1X40	100	2.40
M6045CSP	44596	M6-1X45	100	2.60
M6050CSP	44598	M6-1X50	100	2.90
M6055CSP	44600	M6-1X55	100	3.00
M6060CSP	44602	M6-1X60	100	3.00
M6065CSP	44604	M6-1X65	100	3.60
M6070CSP	44606	M6-1X70	100	3.80
M6075CSP	44608	M6-1X75	100	3.90
M6080CSP	44610	M6-1X80	100	4.00
M6090CSP	44612	M6-1X90	100	4.80
M6100CSP		M6-1X100	100	5.00
M8010CSP	44620	M8-1.25X10	50	2.20
M8012CSP	44622	M8-1.25X12	50	2.40
M8016CSP	44624	M8-1.25X16	50	2.60
M8020CSP	44626	M8-1.25X20	50	2.90
M8025CSP	44628	M8-1.25X25	50	3.30
M8030CSP	44630	M8-1.25X30	50	3.70
M8035CSP	44632	M8-1.25X35	50	4.00
M8040CSP	44634	M8-1.25X40	50	4.60
M8045CSP	44636	M8-1.25X45	50	5.00
M8050CSP	44638	M8-1.25X50	50	5.50
M8055CSP	44640	M8-1.25X55	50	5.90
M8060CSP	44642	M8-1.25X60	50	6.00

More sizes on page 360

Heat Treated Alloy Steel
per ASTM A574M

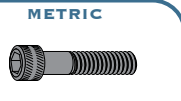

Free Manufacturer's
Certifications Available

BLUE DEVIL® SOCKET HEAD CAP SCREWS
ISO METRIC THREAD

Manufactured to ISO 4762 dimensions
Tensile Strength: 1,220 N/mm² minimum

Kanebridge Part #	Blue Devil® Number	Size	Ctn Qty	Wght Lbs/C
M8065CSP	44644	M8-1.25X65	50	6.80
M8070CSP	44646	M8-1.25X70	50	7.20
M8080CSP	44648	M8-1.25X80	50	8.00
M8090CSP	44650	M8-1.25X90	50	9.00
M8100CSP	44652	M8-1.25X100	50	10.00
M8110CSP	44654	M8-1.25X110	50	10.70
M10012CSP	44672	M10-1.5X12	50	4.20
M10016CSP	44674	M10-1.5X16	50	4.60
M10020CSP	44676	M10-1.5X20	50	5.00
M10025CSP	44678	M10-1.5X25	50	5.70
M10030CSP	44680	M10-1.5X30	50	6.10
M10035CSP	44682	M10-1.5X35	50	6.80
M10040CSP	44684	M10-1.5X40	50	7.50
M10045CSP	44686	M10-1.5X45	50	8.00
M10050CSP	44688	M10-1.5X50	50	8.80
M10055CSP	44690	M10-1.5X55	50	9.60
M10060CSP	44692	M10-1.5X60	50	10.20
M10065CSP	44694	M10-1.5X65	50	10.80
M10070CSP	44696	M10-1.5X70	50	11.60
M10075CSP	44698	M10-1.5X75	50	12.00
M10080CSP	44700	M10-1.5X80	50	12.80
M10090CSP	44702	M10-1.5X90	50	14.20
M10100CSP	44704	M10-1.5X100	50	15.60
M10110CSP	44706	M10-1.5X110	50	17.00
M10130CSP	44710	M10-1.5X130	50	19.80
M12020CSP	44726	M12-1.75X20	25	7.00
M12025CSP	44728	M12-1.75X25	25	7.80
M12030CSP	44730	M12-1.75X30	25	8.60
M12035CSP	44732	M12-1.75X35	25	9.40
M12040CSP	44734	M12-1.75X40	25	10.40
M12045CSP	44736	M12-1.75X45	25	11.40
M12050CSP	44738	M12-1.75X50	25	12.20
M12055CSP	44740	M12-1.75X55	25	13.20
M12060CSP	44742	M12-1.75X60	25	14.00
M12065CSP	44744	M12-1.75X65	25	15.20
M12070CSP	44746	M12-1.75X70	25	16.00
M12075CSP	44748	M12-1.75X75	25	17.20
M12080CSP	44750	M12-1.75X80	25	18.00
M12090CSP	44752	M12-1.75X90	25	20.00
M12100CSP	44754	M12-1.75X100	25	22.00
M12110CSP	44756	M12-1.75X110	25	24.00
M12120CSP	44758	M12-1.75X120	25	25.60
M12130CSP	44760	M12-1.75X130	25	28.00
M12150CSP	44764	M12-1.75X150	25	32.00
M16030CSP	44772	M16-2X30	25	16.80
M16035CSP	44774	M16-2X35	25	19.20
M16040CSP	44776	M16-2X40	25	20.00
M16045CSP	44778	M16-2X45	25	21.20
M16050CSP	44780	M16-2X50	25	23.20
M16055CSP	44782	M16-2X55	25	24.80
M16060CSP	44784	M16-2X60	25	26.80
M16065CSP	44786	M16-2X65	25	28.40
M16070CSP	44788	M16-2X70	25	30.00
M16080CSP	44792	M16-2X80	25	34.00
M16090CSP	44794	M16-2X90	25	37.20
M16100CSP	44796	M16-2X100	25	41.00
M16110CSP	44798	M16-2X110	25	44.00
M16120CSP	44800	M16-2X120	25	48.00
M16130CSP	44802	M16-2X130	25	51.00
M16150CSP	44806	M16-2X150	25	58.00
M16160CSP	44808	M16-2X160	25	60.00
M16180CSP	44810	M16-2X180	25	63.00
M20040CSP	44818	M20-2.5X40	10	32.80
M20050CSP	44822	M20-2.5X50	10	38.00
M20055CSP	44824	M20-2.5X55	10	40.00

More sizes on next column

Heat Treated Alloy Steel
per ASTM A574M

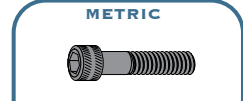

Free Manufacturer's
Certifications Available

BLUE DEVIL® SOCKET HEAD CAP SCREWS
ISO METRIC THREAD

Manufactured to ISO 4762 dimensions
Tensile Strength: 1,220 N/mm² minimum

Kanebridge Part #	Blue Devil® Number	Size	Ctn Qty	Wght Lbs/C
M20060CSP	44826	M20-2.5X60	10	43.00
M20065CSP	44828	M20-2.5X65	10	45.00
M20070CSP	44830	M20-2.5X70	10	48.00
M20075CSP	44832	M20-2.5X75	10	50.00
M20080CSP	44834	M20-2.5X80	10	54.00
M20090CSP	44836	M20-2.5X90	10	58.00
M20100CSP	44838	M20-2.5X100	10	64.00
M20120CSP	44842	M20-2.5X120	10	76.00
M20140CSP	44846	M20-2.5X140	10	87.00
M20150CSP	44848	M20-2.5X150	10	92.00
M20160CSP	44850	M20-2.5X160	10	97.00
M20180CSP	44852	M20-2.5X180	10	99.00
M20200CSP	44854	M20-2.5X200	10	120.00
M24050CSP	44860	M24-3X50	5	66.00
M24060CSP	44864	M24-3X60	5	69.00
M24070CSP	44868	M24-3X70	5	79.00
M24080CSP	44872	M24-3X80	5	87.00
M24090CSP	44874	M24-3X90	5	95.00
M24110CSP	44878	M24-3X110	5	111.00
M24120CSP	44880	M24-3X120	5	119.00
M24130CSP	44882	M24-3X130	5	127.00
M24140CSP	44884	M24-3X140	5	135.00
M24150CSP	44886	M24-3X150	5	143.00
M24200CSP	44892	M24-3X200	5	180.00

Alloy Steel with
Black Oxide Finish

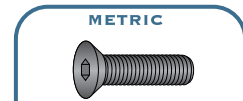

Free Manufacturer's
Certifications Available

BLUE DEVIL® BRAND FLAT HEAD
SOCKET CAP SCREWS / ISO METRIC THREAD

Heads Manufactured to ANSI B18.3.5M dimensions

Kanebridge Part #	Blue Devil® Number	Size	Ctn Qty	Wght Lbs/C
M3008CSFL	19502	M3-0.5X8	100	0.10
M3010CSFL	19504	M3-0.5X10	100	0.10
M3012CSFL	19506	M3-0.5X12	100	0.10
M3016CSFL	19508	M3-0.5X16	100	0.10
M3020CSFL	19510	M3-0.5X20	100	0.20
M4008CSFL	19520	M4-0.7X8	100	0.20
M4010CSFL	19522	M4-0.7X10	100	0.20
M4012CSFL	19524	M4-0.7X12	100	0.30
M4016CSFL	19526	M4-0.7X16	100	0.30
M4020CSFL	19528	M4-0.7X20	100	0.40
M4025CSFL	19530	M4-0.7X25	100	0.50
M4030CSFL	19532	M4-0.7X30	100	0.60

More sizes on page 361

Alloy Steel with
Black Oxide Finish

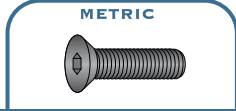

Free Manufacturer's
Certifications Available

**BLUE DEVIL® BRAND FLAT HEAD
SOCKET CAP SCREWS / ISO METRIC THREAD**

Heads Manufactured to ANSI B18.3.5M dimensions

Kanebridge Part #	Blue Devil® Number	Size	Ctn Qty	Wght Lbs/C
M5008CSFL	19544	M5-0.8X8	100	0.30
M5010CSFL	19546	M5-0.8X10	100	0.40
M5012CSFL	19548	M5-0.8X12	100	0.40
M5016CSFL	19550	M5-0.8X16	100	0.50
M5020CSFL	19552	M5-0.8X20	100	0.70
M5025CSFL	19554	M5-0.8X25	100	0.80
M5030CSFL	19556	M5-0.8X30	100	0.90
M6008CSFL	19570	M6-1X8	100	0.50
M6010CSFL	19572	M6-1X10	100	0.60
M6012CSFL	19574	M6-1X12	100	0.70
M6016CSFL	19576	M6-1X16	100	0.80
M6020CSFL	19578	M6-1X20	100	1.00
M6025CSFL	19580	M6-1X25	100	1.10
M6030CSFL	19582	M6-1X30	100	1.30
M6035CSFL	19584	M6-1X35	100	1.50
M6040CSFL	19586	M6-1X40	100	1.70
M8010CSFL	19596	M8-1.25X10	100	1.20
M8012CSFL	19598	M8-1.25X12	100	1.30
M8016CSFL	19600	M8-1.25X16	100	1.60
M8020CSFL	19602	M8-1.25X20	100	1.90
M8025CSFL	19604	M8-1.25X25	100	2.20
M8030CSFL	19606	M8-1.25X30	100	2.50
M8035CSFL	19608	M8-1.25X35	100	2.90
M8040CSFL	19610	M8-1.25X40	100	3.20
M10012CSFL	19626	M10-1.5X12	50	2.20
M10020CSFL	19628	M10-1.5X20	50	3.10
M10025CSFL	19630	M10-1.5X25	50	3.60
M10030CSFL	19632	M10-1.5X30	50	4.10
M10035CSFL	19634	M10-1.5X35	50	4.60
M10040CSFL	19636	M10-1.5X40	50	5.20
M10045CSFL	19638	M10-1.5X45	50	5.80
M10050CSFL	19640	M10-1.5X50	50	6.40
M12020CSFL	19658	M12-1.75X20	25	5.20
M12030CSFL	19662	M12-1.75X30	25	6.20
M12035CSFL	19664	M12-1.75X35	25	7.00
M12040CSFL	19666	M12-1.75X40	25	7.80
M12045CSFL	19668	M12-1.75X45	25	8.00
M12050CSFL	19670	M12-1.75X50	25	9.40
M16035CSFL	19690	M16-2X35	25	12.80
M16050CSFL	19696	M16-2X50	25	17.20

Alloy Steel with
Black Oxide Finish

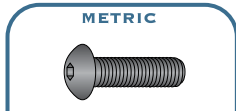

Free Manufacturer's
Certifications Available

**BLUE DEVIL® BUTTON HEAD SOCKET CAP SCREWS
ISO METRIC THREAD**

Manufactured to ISO 7380 dimensions
Tensile Strength: 1,040 MPa minimum

Kanebridge Part #	Blue Devil® Number	Size	Ctn Qty	Wght Lbs/C
M3008CSB	20502	M3-0.5X8	100	0.10
M3010CSB	20504	M3-0.5X10	100	0.10
M3012CSB	20506	M3-0.5X12	100	0.20
M4008CSB	20510	M4-0.7X8	100	0.30
M4010CSB	20512	M4-0.7X10	100	0.30

More sizes on next column

Alloy Steel with
Black Oxide Finish

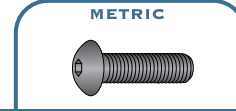

Free Manufacturer's
Certifications Available

**BLUE DEVIL® BUTTON HEAD SOCKET CAP SCREWS
ISO METRIC THREAD**

Manufactured to ISO 7380 dimensions
Tensile Strength: 1,040 MPa minimum

Kanebridge Part #	Blue Devil® Number	Size	Ctn Qty	Wght Lbs/C
M4012CSB	20514	M4-0.7X12	100	0.30
M4016CSB	20516	M4-0.7X16	100	0.40
M5010CSB	20518	M5-0.8X10	100	0.50
M5012CSB	20520	M5-0.8X12	100	0.50
M5016CSB	20522	M5-0.8X16	100	0.60
M5020CSB	20524	M5-0.8X20	100	0.80
M5025CSB	20526	M5-0.8X25	100	0.90
M5030CSB	20528	M5-0.8X30	100	1.00
M6010CSB	20530	M6-1X10	100	0.70
M6012CSB	20532	M6-1X12	100	0.70
M6016CSB	20534	M6-1X16	100	0.90
M6020CSB	20536	M6-1X20	100	1.10
M6025CSB	20538	M6-1X25	100	1.20
M6030CSB	20540	M6-1X30	100	1.40
M8010CSB	20542	M8-1.25X10	100	1.00
M8012CSB	20544	M8-1.25X12	100	1.20
M8016CSB	20546	M8-1.25X16	100	1.50
M8020CSB	20548	M8-1.25X20	100	1.90
M8025CSB	20550	M8-1.25X25	100	2.30
M8030CSB	20552	M8-1.25X30	100	2.80
M8040CSB	20556	M8-1.25X40	100	3.60
M10016CSB	20558	M10-1.5X16	100	3.20
M10020CSB	20560	M10-1.5X20	100	3.70
M10025CSB	20562	M10-1.5X25	100	4.20
M10030CSB	20564	M10-1.5X30	50	4.80
M10040CSB	20568	M10-1.5X40	50	5.90

Alloy Steel with
Black Oxide Finish

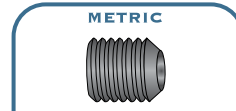

Free Manufacturer's
Certifications Available

**BLUE DEVIL® BRAND SOCKET SET SCREWS
CUP POINT / ISO METRIC THREAD**

Manufactured to ISO 4029 dimensions
Black Oxide Finish

Kanebridge Part #	Blue Devil® Number	Size	Ctn Qty	Wght Lbs/C
M3003SSC	33500	M3-0.5X3	100	0.10
M3004SSC	33502	M3-0.5X4	100	0.10
M3005SSC	33504	M3-0.5X5	100	0.10
M3006SSC	33506	M3-0.5X6	100	0.10
M3008SSC	33508	M3-0.5X8	100	0.10
M3012SSC	33512	M3-0.5X12	100	0.10
M4004SSC	33514	M4-0.7X4	100	0.10
M4005SSC	33516	M4-0.7X5	100	0.10
M4006SSC	33518	M4-0.7X6	100	0.10
M4008SSC	33520	M4-0.7X8	100	0.10
M4010SSC	33522	M4-0.7X10	100	0.10
M4012SSC	33524	M4-0.7X12	100	0.20
M4016SSC	33526	M4-0.7X16	100	0.20
M4020SSC	33528	M4-0.7X20	100	0.30
M4025SSC	33530	M4-0.7X25	100	0.40
M5005SSC	33532	M5-0.8X5	100	0.10
M5006SSC	33534	M5-0.8X6	100	0.10
M5008SSC	33536	M5-0.8X8	100	0.20
M5010SSC	33538	M5-0.8X10	100	0.20

More sizes on page 362

Alloy Steel with
Black Oxide Finish

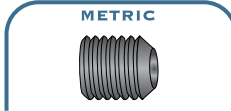

Free Manufacturer's
Certifications Available

BLUE DEVIL® BRAND SOCKET SET SCREWS
CUP POINT / ISO METRIC THREAD

Manufactured to ISO 4029 dimensions
Black Oxide Finish

Kanebridge Part #	Blue Devil® Number	Size	Ctn Qty	Wght Lbs/C
M5012SSC	33540	M5-0.8X12	100	0.30
M5016SSC	33542	M5-0.8X16	100	0.40
M5020SSC	33544	M5-0.8X20	100	0.50
M6006SSC	33548	M6-1X6	100	0.10
M6008SSC	33550	M6-1X8	100	0.20
M6010SSC	33552	M6-1X10	100	0.30
M6012SSC	33554	M6-1X12	100	0.40
M6016SSC	33556	M6-1X16	100	0.50
M6020SSC	33558	M6-1X20	100	0.60
M6025SSC	33560	M6-1X25	100	1.00
M6030SSC	33562	M6-1X30	100	1.00
M6040SSC	33566	M6-1X40	100	1.50
M8008SSC	33568	M8-1.25X8	100	0.40
M8012SSC	33572	M8-1.25X12	100	0.60
M8010SSC	33570	M8-1.25X10	100	0.50
M8016SSC	33574	M8-1.25X16	100	0.90
M8020SSC	33576	M8-1.25X20	100	1.00
M8025SSC	33578	M8-1.25X25	100	1.50
M8030SSC	33580	M8-1.25X30	100	1.80
M8035SSC	33582	M8-1.25X35	100	2.20
M8040SSC	33584	M8-1.25X40	100	2.60
M8045SSC	33586	M8-1.25X45	100	2.80
M8050SSC	33588	M8-1.25X50	100	3.20
M10010SSC	33590	M10-1.5X10	50	0.80
M10012SSC	33592	M10-1.5X12	50	1.00
M10016SSC	33594	M10-1.5X16	50	1.10
M10020SSC	33596	M10-1.5X20	50	1.80
M10025SSC	33598	M10-1.5X25	50	2.30
M10030SSC	33600	M10-1.5X30	50	2.90
M10035SSC	33602	M10-1.5X35	50	3.40
M10045SSC	33606	M10-1.5X45	25	4.40
M10050SSC	33608	M10-1.5X50	25	5.00
M12012SSC	33610	M12-1.75X12	25	1.30
M12016SSC	33612	M12-1.75X16	25	2.10
M12020SSC	33614	M12-1.75X20	25	2.40
M12025SSC	33616	M12-1.75X25	25	3.20
M12030SSC	33618	M12-1.75X30	25	4.20
M12035SSC	33620	M12-1.75X35	25	4.80
M12040SSC	33622	M12-1.75X40	25	5.60
M12045SSC	33624	M12-1.75X45	10	6.30
M12050SSC	33626	M12-1.75X50	10	6.70
M16016SSC	33628	M16-2X16	10	4.00
M16020SSC	33630	M16-2X20	10	4.20
M16030SSC	33634	M16-2X30	10	7.10
M16035SSC	33636	M16-2X35	10	8.50
M16040SSC	33638	M16-2X40	10	10.00
M16050SSC	33642	M16-2X50	10	13.20
M16060SSC	33646	M16-2X60	10	15.60
M20020SSC	33648	M20-2.5X20	10	6.30
M20035SSC	33654	M20-2.5X35	10	12.30
M20040SSC	33656	M20-2.5X40	10	14.70
M20050SSC	33660	M20-2.5X50	5	19.00
M20060SSC	33664	M20-2.5X60	5	23.80

Alloy Steel with
Black Oxide Finish

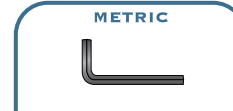

BLUE DEVIL® BRAND HEX WRENCHES
SHORT ARM

Alloy Steel Construction

Kanebridge Part #	Blue Devil® Number	Size	Ctn Qty	Wght Lbs/C
M1.5KHS	22500	M1.5	100	0.23
M2KHS	22501	M2	100	0.41
M2.5KHS	22502	M2.5	100	0.70
M3KHS	22503	M3	100	1.12
M4KHS	22504	M4	100	2.26
M5KHS	22505	M5	100	4.03
M6KHS	22506	M6	50	6.60
M8KHS	22507	M8	50	13.00
M10KHS	22508	M10	25	22.80
M12KHS	22510	M12	10	37.30
M14KHS	22511	M14	10	58.40
M17KHS	22512	M17	1	111.00
M19KHS	22513	M19	1	152.00

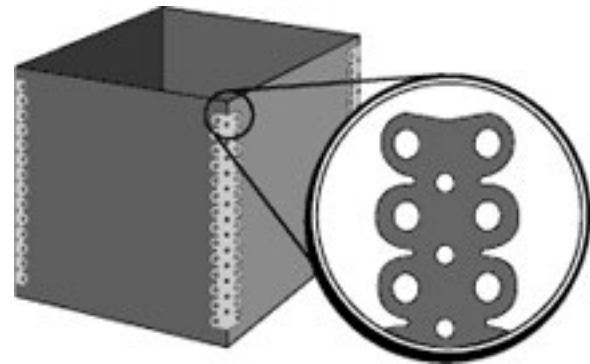

*We now package
Blue Devil® Sockets in boxes
with Steel re-inforced corners*

ZAMAC #3 Zinc Alloy

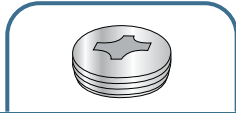

PHILLIPS PIPE PLUG
NPT THREAD

ZAMAC #3 Zinc Alloy

Kanebridge Part #	Size	Ctn Qty	Wght Lbs/C
00500PPPA	1/2-14	1000	1.57

ZAMAC #3 Zinc Alloy

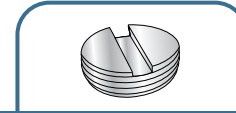

SLOTTED PIPE PLUG
NPT THREAD

ZAMAC #3 Zinc Alloy

Kanebridge Part #	Size	Ctn Qty	Wght Lbs/C
00500PPSA	1/2-14	1000	1.35
00750PPSA	3/4-14	1000	1.85

Obtain the latest pricing for any Blue Devil® item at www.kanebridge.com

Place an order through FasNet™, our online ordering system, and receive **2%** off.

Stainless Steel



MILITARY GRADE
Certification to NAS1352
part numbers also available
Free Manufacturer's
Certifications Available

SOCKET HEAD CAP SCREWS
MS16995

Coarse Thread

Tested and Certified to Military Standards / Parts are DFAR-Compliant
All Items Are Made In The U.S.A.

Part #	Size	Ctn Qty	Wght Lbs/M	Part #	Size	Ctn Qty	Wght Lbs/M
MS16995-1	2-56X3/16	1000	0.60	MS16995-25	8-32X3/8	1000	3.80
MS16995-2	2-56X1/4	1000	0.70	MS16995-26	8-32X1/2	1000	4.50
MS16995-3	2-56X3/8	1000	0.90	MS16995-27	8-32X5/8	1000	5.30
MS16995-4	2-56X1/2	1000	1.05	MS16995-28	8-32X3/4	1000	5.70
MS16995-9	4-40X1/4	1000	1.25	MS16995-35	10-24X3/8	1000	5.70
MS16995-10	4-40X3/8	1000	1.50	MS16995-36	10-24X1/2	1000	6.30
MS16995-11	4-40X1/2	1000	1.80	MS16995-37	10-24X5/8	1000	7.10
MS16995-12	4-40X5/8	1000	2.00	MS16995-38	10-24X5/8	1000	7.80
MS16995-13	4-40X3/4	1000	3.00	MS16995-39	10-24X7/8	1000	8.70
MS16995-16	6-32X1/4	1000	2.05	MS16995-40	10-24X1	1000	9.40
MS16995-17	6-32X3/8	1000	2.50	MS16995-48	1/4-20X1/2	200	11.30
MS16995-18	6-32X1/2	1000	3.25	MS16995-49	1/4-20X5/8	200	12.70
MS16995-19	6-32X5/8	1000	3.60	MS16995-50	1/4-20X3/4	200	13.90
MS16995-20	6-32X3/4	1000	5.00	MS16995-51	1/4-20X7/8	200	15.50
MS16995-21	6-32X1	1000	5.00	MS16995-52	1/4-20X1	200	16.65

Stainless Steel



MILITARY GRADE
Certification to NAS1351
part numbers also available
Free Manufacturer's
Certifications Available

SOCKET HEAD CAP SCREWS
MS16996

Fine Thread

Tested and Certified to Military Standards / Parts are DFAR-Compliant
All Items Are Made In The U.S.A.

Part #	Size	Ctn Qty	Wght Lbs/M	Part #	Size	Ctn Qty	Wght Lbs/M
MS16996-1	0-80X1/8	500	0.30	MS16996-21	1/4-28X1/2	200	11.70
MS16996-2	0-80X3/16	500	0.45	MS16996-22	1/4-28X5/8	200	13.20
MS16996-3	0-80X1/4	500	0.48	MS16996-23	1/4-28X3/4	200	15.00
MS16996-4	0-80X3/8	500	0.50	MS16996-24	1/4-28X1	200	18.00
MS16996-9	10-32X3/8	1000	5.70				
MS16996-10	10-32X1/2	1000	6.70				
MS16996-11	10-32X5/8	1000	7.40				
MS16996-12	10-32X3/4	1000	8.20				
MS16996-13	10-32X7/8	1000	9.00				
MS16996-14	10-32X1	1000	9.80				

Heat Treated Alloy Steel
Cadmium Yellow Plated



MILITARY GRADE
Certification to NAS part
numbers also available
Free Manufacturer's
Certifications Available

SOCKET HEAD CAP SCREWS
MS16997

Tested and Certified to Military Standards / Parts are DFAR-Compliant
All Items Are Made In The U.S.A.

Part #	Size	Ctn Qty	Wght Lbs/M	Part #	Size	Ctn Qty	Wght Lbs/M
MS16997-18	6-32x1/4	100	1.91	MS16997-76	5/16-18x1/2	100	19.17
MS16997-20	6-32x1/2	100	2.80	MS16997-78	5/16-18x3/4	100	23.63
MS16997-22	6-32x3/4	100	3.44	MS16997-80	5/16-18x1	100	29.00
MS16997-24	6-32x1	100	4.60	MS16997-81	5/16-18x1 1/4	100	32.80
MS16997-32	8-32x1/2	100	4.30	MS16997-82	5/16-18x1 1/2	50	36.20
MS16997-34	8-32x3/4	100	5.70	MS16997-83	5/16-18x1 3/4	50	43.60
MS16997-36	8-32x1	100	6.40	MS16997-84	5/16-18x2	50	48.30
MS16997-37	8-32x1 1/4	100	8.30	MS16997-85	5/16-18x2 1/4	50	55.00
MS16997-38	8-32x1 1/2	100	9.55	MS16997-86	5/16-18x2 1/2	25	59.40
MS16997-44	10-24x1/2	100	5.95	MS16997-87	5/16-18x2 3/4	25	63.40
MS16997-46	10-24x3/4	100	7.75	MS16997-88	5/16-18x3	25	670.00
MS16997-48	10-24x1	100	8.83	MS16997-97	3/8-16x3/4	100	38.00
MS16997-49	10-24x1 1/4	50	11.20	MS16997-98	3/8-16x7/8	100	40.10
MS16997-50	10-24x1 1/2	50	12.60	MS16997-99	3/8-16x1	50	43.00
MS16997-51	10-24x1 3/4	50	15.00	MS16997-100	3/8-16x1 1/4	50	51.40
MS16997-52	10-24x2	50	16.90	MS16997-101	3/8-16x1 1/2	50	56.80
MS16997-58	1/4-20x1/2	100	11.40	MS16997-102	3/8-16x1 3/4	25	65.75
MS16997-60	1/4-20x3/4	100	13.80	MS16997-103	3/8-16x2	25	69.50
MS16997-62	1/4-20x1	100	16.90	MS16997-104	3/8-16x2 1/4	25	78.20
MS16997-63	1/4-20x1 1/4	100	20.00	MS16997-105	3/8-16x2 1/2	10	84.20
MS16997-64	1/4-20x1 1/2	100	24.20	MS16997-106	3/8-16x2 3/4	10	94.00
MS16997-65	1/4-20x1 3/4	50	24.90	MS16997-107	3/8-16x3	10	102.00
MS16997-66	1/4-20x2	50	29.20				
MS16997-67	1/4-20x2 1/4	50	31.75				
MS16997-68	1/4-20x2 1/2	50	35.80				
MS16997-69	1/4-20x2 3/4	50	38.60				

Stainless Steel



MILITARY GRADE
Certification to MS16996
part numbers also available
Free Manufacturer's
Certifications Available

SOCKET HEAD CAP SCREWS
NAS1351

Fine Thread

Tested and Certified to Military Standards / Parts are DFAR-Compliant
All Items Are Made In The U.S.A.

Part #	Size	Ctn Qty	Wght Lbs/M	Part #	Size	Ctn Qty	Wght Lbs/M
NAS1351C002	0-80x1/8	500	0.16	NAS1351C48	1/4-28x1/2	200	11.40
NAS1351C003	0-80x3/16	500	0.20	NAS1351C410	1/4-28x5/8	200	13.00
NAS1351C004	0-80x1/4	500	0.23	NAS1351C412	1/4-28x3/4	200	14.40
NAS1351C006	0-80x3/8	500	0.30	NAS1351C416	1/4-28x1	200	17.30
NAS1351C36	10-32x3/8	1,000	5.35				
NAS1351C38	10-32x1/2	1,000	6.20				
NAS1351C310	10-32x5/8	1,000	7.00				
NAS1351C312	10-32x3/4	1,000	7.80				
NAS1351C314	10-32x7/8	1,000	8.70				
NAS1351C316	10-32x1	1,000	9.40				

A286 Stainless Steel

MILITARY GRADE



Free Manufacturer's Certifications Available

**SOCKET HEAD CAP SCREWS
NAS1351A**

Fine Thread / A286 Stainless, Vacuum Age Hardened & Argon Cooled
Tested and Certified to Military Standards / Parts are DFAR-Compliant
All Items Are Made In The U.S.A.

Part #	Size	Ctn Qty	Wght Lbs/M	Part #	Size	Ctn Qty	Wght Lbs/M
NAS1351N36	10-32x3/8	100	5.43	NAS1351N312	10-32x3/4	100	7.75
NAS1351N38	10-32x1/2	100	6.13	NAS1351N314	10-32x7/8	100	8.60
NAS1351N310	10-32x5/8	100	7.00	NAS1351N316	10-32x1	100	9.50

A286 Stainless Steel

MILITARY GRADE



Free Manufacturer's Certifications Available

**SOCKET HEAD CAP SCREWS
NAS1352A**

Coarse Thread / A286 Stainless, Vacuum Age Hardened & Argon Cooled
Tested and Certified to Military Standards / Parts are DFAR-Compliant
All Items Are Made In The U.S.A.

Part #	Size	Ctn Qty	Wght Lbs/M	Part #	Size	Ctn Qty	Wght Lbs/M
NAS1352N023	2-56x3/16	100	0.48	NAS1352N064	6-32x1/4	100	1.92
NAS1352N024	2-56x1/4	100	0.55	NAS1352N066	6-32x3/8	100	2.32
NAS1352N026	2-56x3/8	100	0.71	NAS1352N068	6-32x1/2	100	2.68
NAS1352N028	2-56x1/2	100	0.67	NAS1352N0610	6-32x5/8	100	3.11
				NAS1352N0612	6-32x3/4	100	3.50
NAS1352N044	4-40x1/4	100	1.12	NAS1352N0614	6-32x7/8	100	3.83
NAS1352N046	4-40x3/8	100	1.37	NAS1352N0616	6-32x1	100	4.29
NAS1352N048	4-40x1/2	100	1.60				
NAS1352N0410	4-40x5/8	100	1.85	NAS1352N084	8-32x1/4	100	3.09
NAS1352N0412	4-40x3/4	100	2.14	NAS1352N086	8-32x3/8	100	3.65
				NAS1352N088	8-32x1/2	100	21.25
				NAS1352N0810	8-32x5/8	100	4.86
				NAS1352N0812	8-32x3/4	100	5.42
				NAS1352N0814	8-32x7/8	100	6.00
				NAS1352N0816	8-32x1	100	6.58
				NAS1352N36	10-24x3/8	100	5.29
				NAS1352N38	10-24x1/2	100	6.00
				NAS1352N310	10-24x5/8	100	6.71
				NAS1352N312	10-24x3/4	100	7.40
				NAS1352N314	10-24x7/8	100	8.20
				NAS1352N316	10-24x1	100	9.00

Stainless Steel

MILITARY GRADE

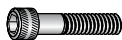

Certification to MS16995 part numbers are also available

Free Manufacturer's Certifications Available

**SOCKET HEAD CAP SCREWS
NAS1352**

Coarse Thread

Tested and Certified to Military Standards / Parts are DFAR-Compliant
All Items Are Made In The U.S.A.

Part #	Size	Ctn Qty	Wght Lbs/M	Part #	Size	Ctn Qty	Wght Lbs/M
NAS1352C023	2-56x3/16	1,000	0.48	NAS1352C084	8-32x1/4	1,000	3.05
NAS1352C024	2-56x1/4	1,000	0.53	NAS1352C086	8-32x3/8	1,000	6.35
NAS1352C025	2-56x5/16	1,000	0.63	NAS1352C088	8-32x1/2	1,000	4.20
NAS1352C026	2-56x3/8	1,000	0.73	NAS1352C0810	8-32x5/8	1,000	4.80
NAS1352C028	2-56x1/2	1,000	0.85	NAS1352C0812	8-32x3/4	1,000	5.40
NAS1352C043	4-40x3/16	1,000	0.97	NAS1352C36	10-24x3/8	1,000	5.25
NAS1352C044	4-40x1/4	1,000	1.10	NAS1352C38	10-24x1/2	1,000	6.00
NAS1352C045	4-40x5/16	1,000	1.20	NAS1352C310	10-24x5/8	1,000	6.70
NAS1352C046	4-40x3/8	1,000	1.35	NAS1352C312	10-24x3/4	1,000	7.50
NAS1352C047	4-40x7/16	1,000	1.50	NAS1352C314	10-24x7/8	1,000	8.20
NAS1352C048	4-40x1/2	1,000	1.60	NAS1352C316	10-24x1	1,000	9.00
NAS1352C0410	4-40x5/8	1,000	1.85				
NAS1352C0412	4-40x3/4	1,000	2.10	NAS1352C48	1/4-20x1/2	200	11.20
				NAS1352C410	1/4-20x5/8	200	12.50
NAS1352C064	6-32x1/4	1,000	1.90	NAS1352C412	1/4-20x3/4	200	13.70
NAS1352C066	6-32x3/8	1,000	2.30	NAS1352C414	1/4-20x7/8	200	15.00
NAS1352C067	6-32x7/16	1,000	2.50	NAS1352C416	1/4-20x1	200	16.40
NAS1352C068	6-32x1/2	1,000	2.70	NAS1352C420	1/4-20x1 1/4	100	18.95
NAS1352C0610	6-32x5/8	1,000	3.10	NAS1352C424	1/4-20x1 1/2	100	23.05
NAS1352C0612	6-32x3/4	1,000	3.40	NAS1352C428	1/4-20x1 3/4	100	25.65
NAS1352C0616	6-32x1	1,000	4.30	NAS1352C432	1/4-20x2	50	30.05

Blue Devil[®] Sockets

***High Quality, Domestic Sockets
in Packaged Quantities that
Ship the Same Day***

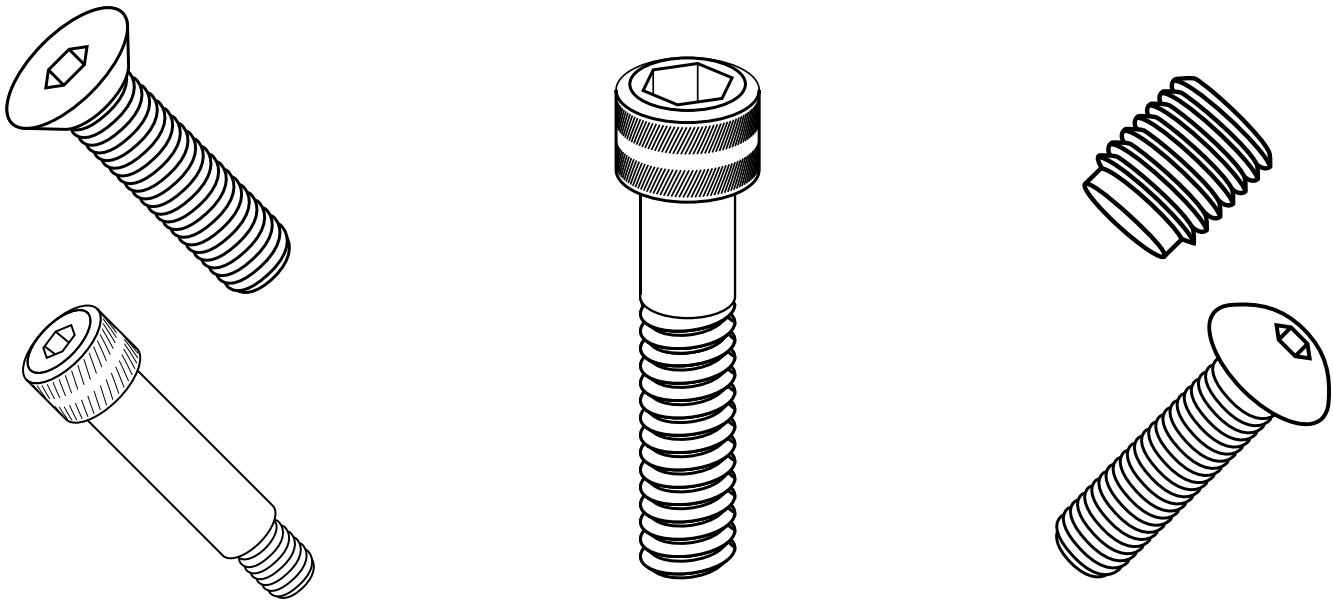

Kanebridge

***Precise quality. Full traceability.
Instant access to inventory.
Superb customer service.***

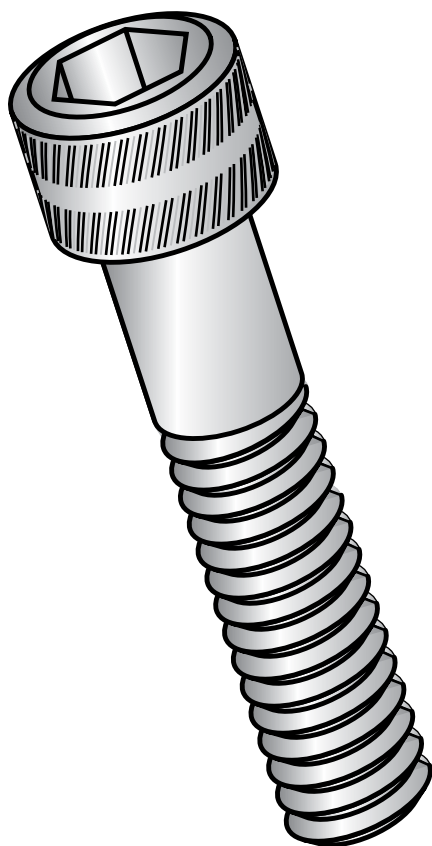

It is a combination you just won't find
anywhere else:

- Precision-made sockets
- Brand-name recognition
- Convenient packaged quantities
- Extensive product variety

Alloy Steel

18-8 Stainless

Inch standard & Metric items

- Same-Day Shipping until 5 pm
- Full traceability
- Free certification
- 2% discount for online orders

You will find it at Kanebridge. Every Day.

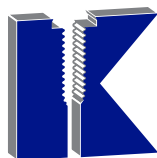

**KANEBRIDGE
CORPORATION**

New Jersey . Illinois . California

888.222.9221

201.337.2300

201.337.2301 (Fax)

www.kanebridge.com

OVER 1,700 DOMESTIC SOCKETS

AVAILABLE FOR SAME-DAY SHIPPING!



**KANEBRIDGE
CORPORATION**
New Jersey | Illinois | California

T: (800) 222-9221
F: (201) 337-2301

sales@kanebridge.com
www.kanebridge.com